

Molto
by Norway Says and Hallgeir Homstvedt



Numerous opportunities

MOLTO is a sofa system that offers many creative options and solutions. MOLTO is adapted to smaller, intimate meeting situations. On the other hand, MOLTO can easily fit into a private living room thanks to its simplicity and classic form. In the high version, MOLTO is like a haven in noisy surroundings. As the name suggests MOLTO is a sofa with numerous opportunities and is highly adaptable to many situations.

See page 114 for complete specifications



Hjelle

Molto
by Norway Says and Hallgeir Homstvedt



Design Norway Says and Hallgeir Homstvedt

DAY MOLTO's basic modules are 1, 2, and 3 seater in high or low version. The modular system also allows you to build different corner solutions or open-ended sofas etc. Molto is delivered with fixed seat and with loose, reversible back cushions with covers that are removable for easier cleaning.



Basic modules · 1 height

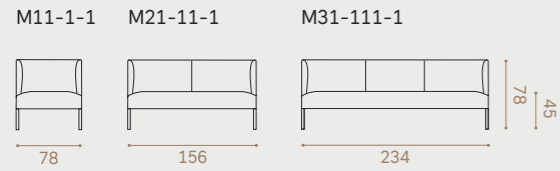

Mixed heights, examples

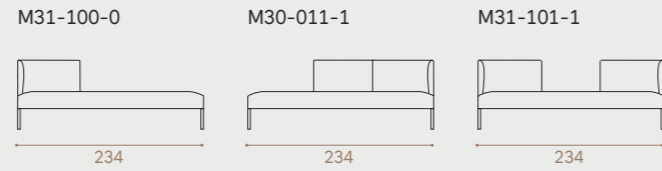

Open sides, examples

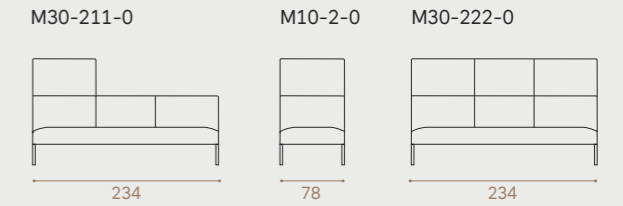
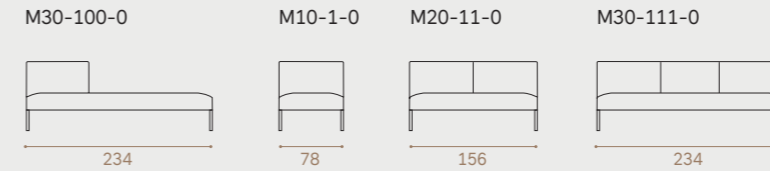

Basic modules · 2 height

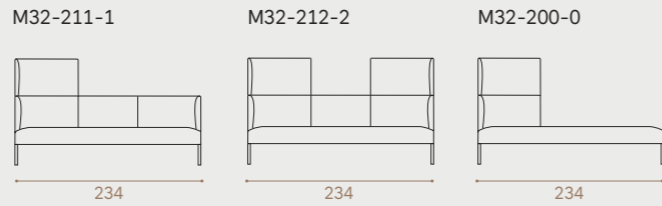
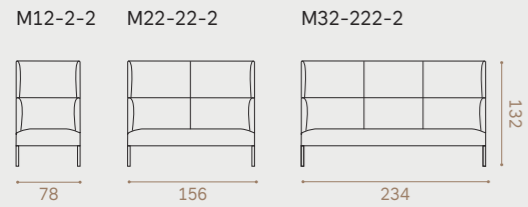

Combinations, examples

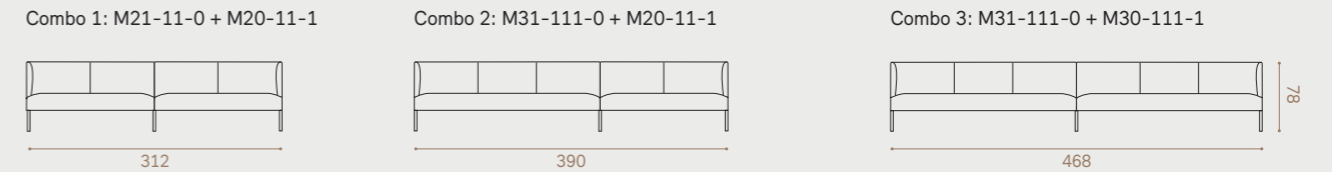

Basic modules · 0 height

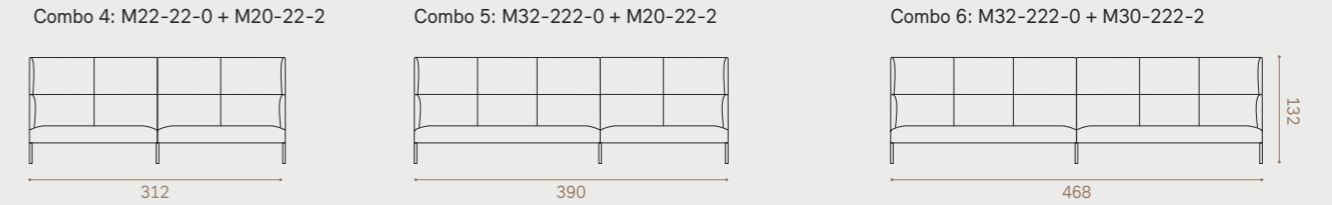
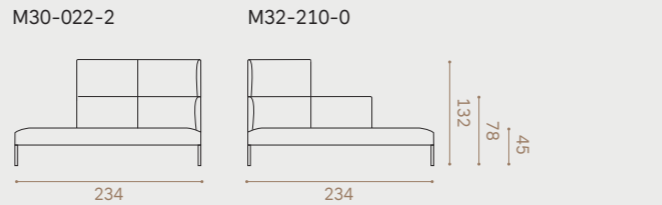
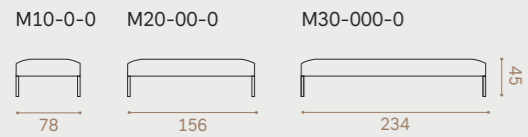

One open side, examples

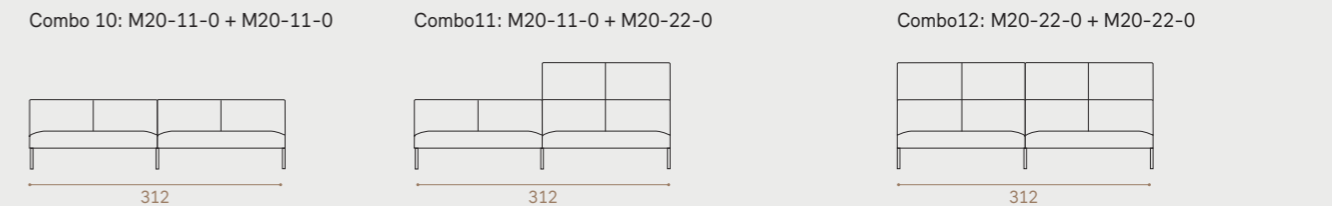
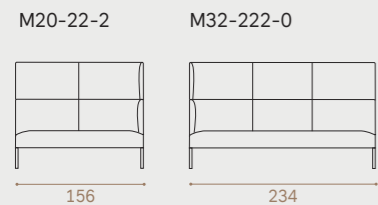
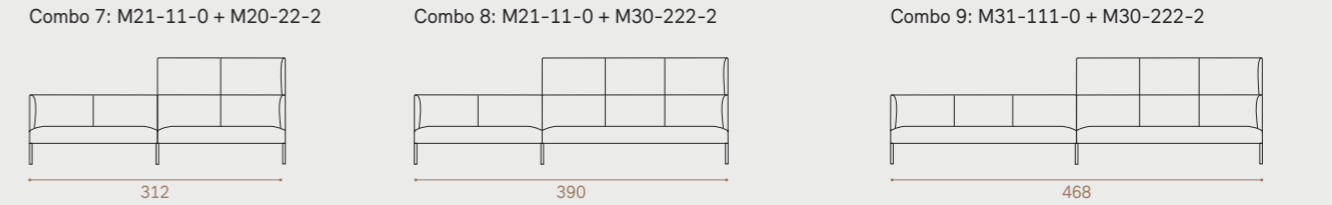
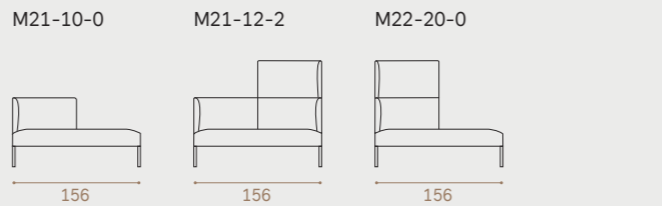
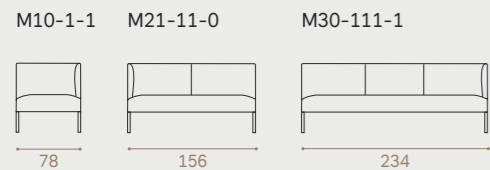

Combo 13: M21-11-1 + M20-22-2

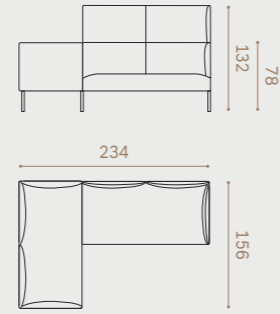

Combo 14: M21-11-0 + M22-22-2

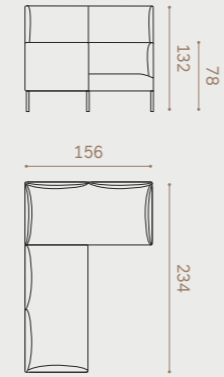

Combo 15: M21-11-1 + M30-222-2

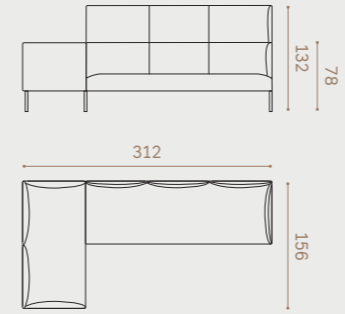

Combo 16: M31-111-0 + M32-222-2

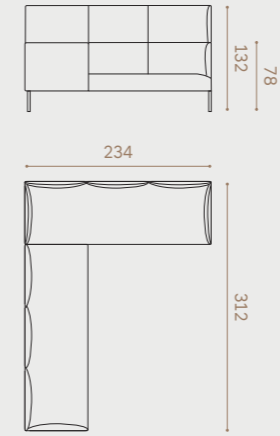

Combo 17: M21-11-1 + M20-11-1

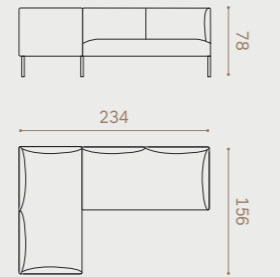

Combo 19: M31-111-1 + M30-222-0

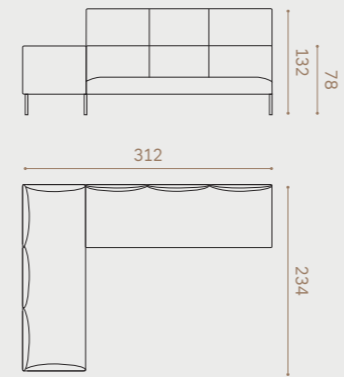

Combo 20: M30-011-0 + M22-21-0

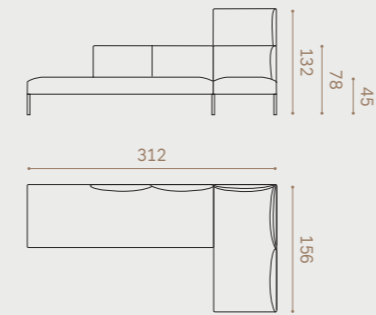

Combo 21: M20-12-0 + M22-21-0 + M21-10-0

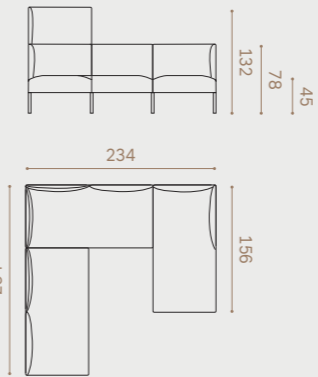

Combo 22: M30-012-2 + M20-22-0 + M32-210-0

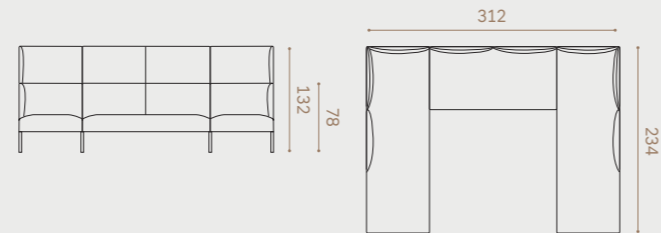

Combo 23: M20-11-1 + M30-111-0 + M21-11-0

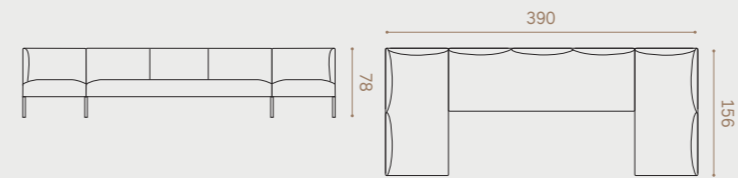

MOLTO | Standard - 0 height

M10-0-0

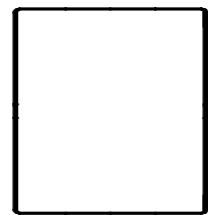
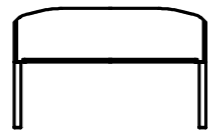

M20-00-0

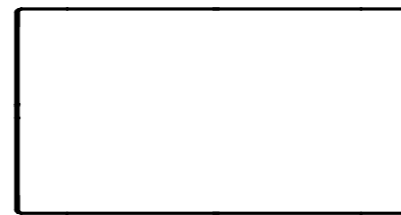
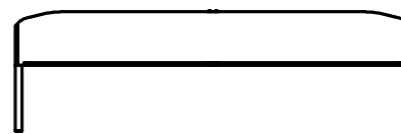

M30-000-0

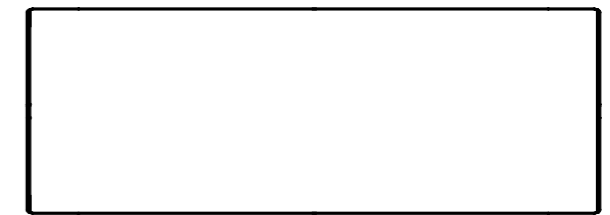
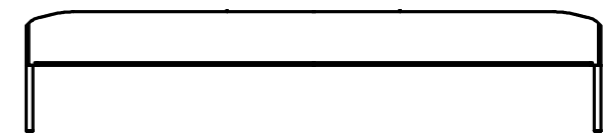

MOLTO | Standard - 1 height

M11-1-1

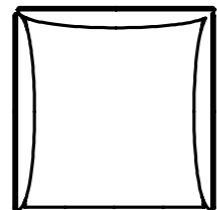
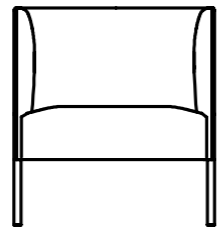
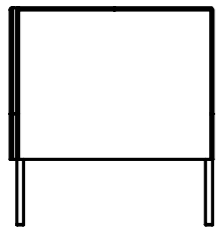

M21-11-1

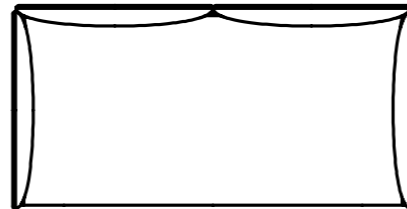
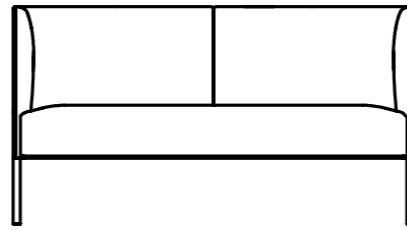

M31-111-1

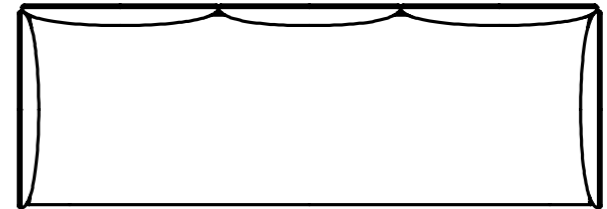
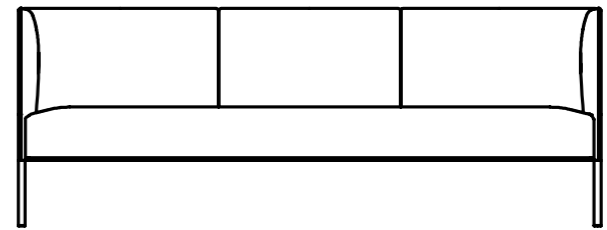

MOLTO | Standard - 2 heights

M12-2-2

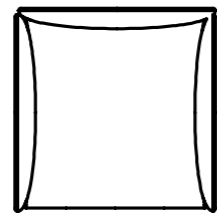
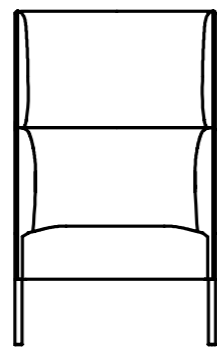
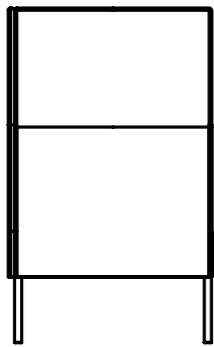

M22-22-2

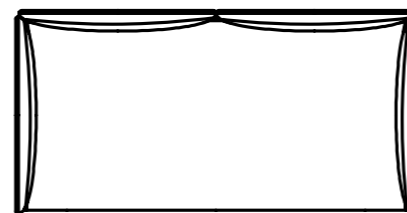
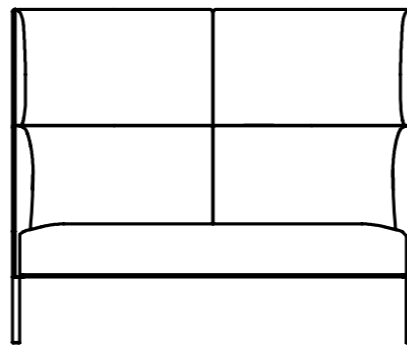

M32-222-2

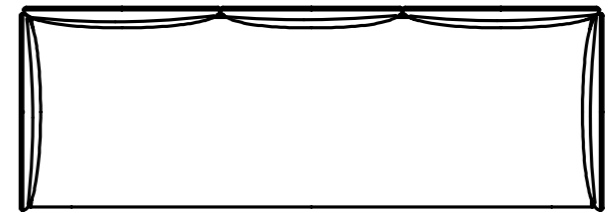
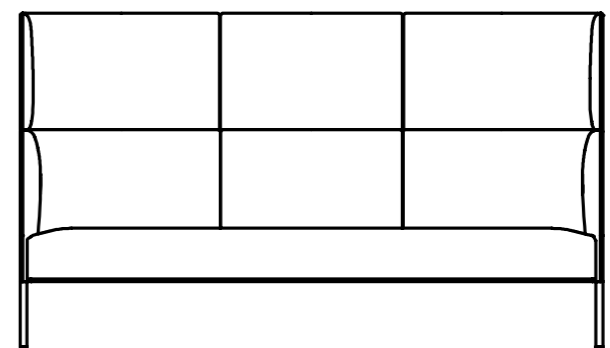

MOLTO | Open 1 side - 1 height

M10-1-1

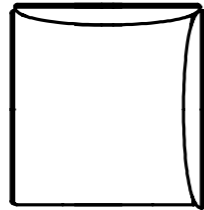
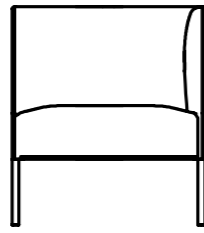
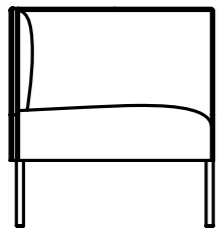

M20-11-1

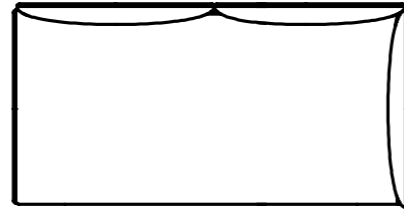
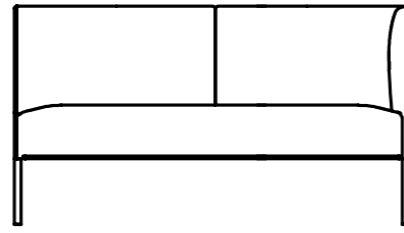

M30-111-1

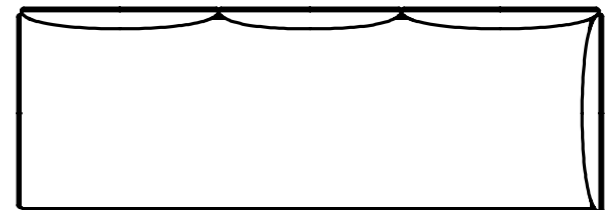
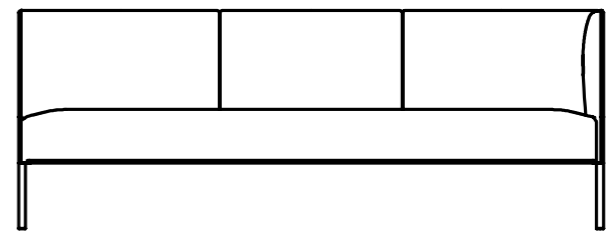

M11-1-0

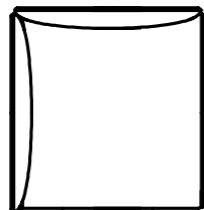
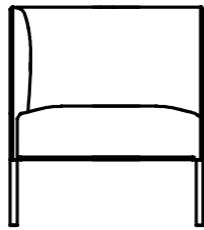
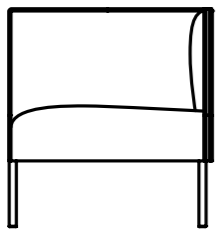

M21-11-0

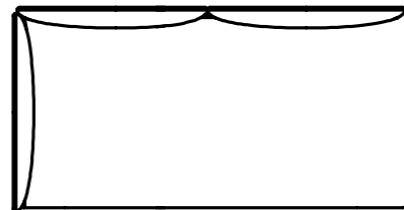
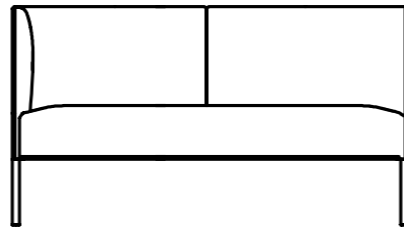

M31-11-0

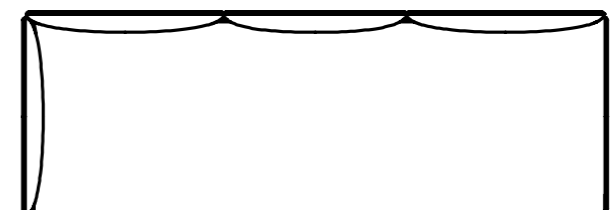
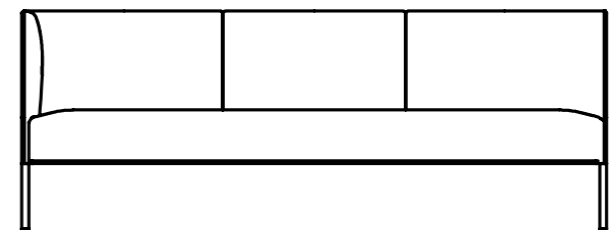

MOLTO | Open 1 side - 2 heights

M10-2-2

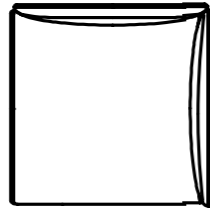
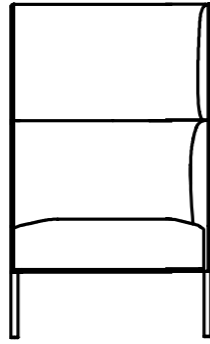
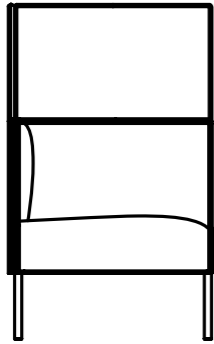

M20-22-2

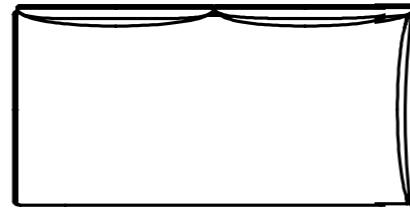
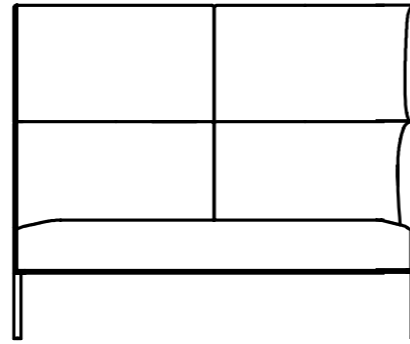

M30-222-2

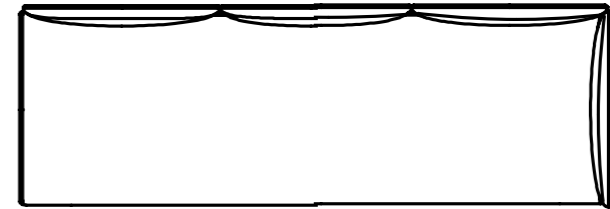
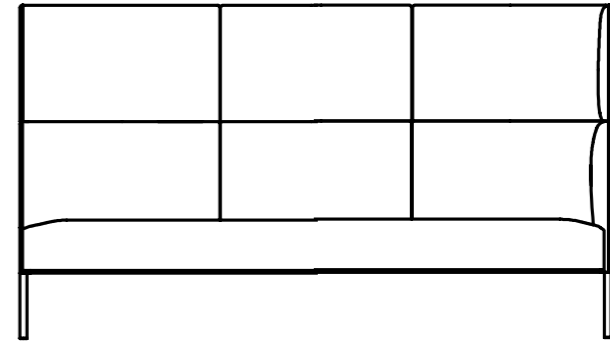

M12-2-0

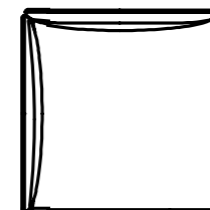
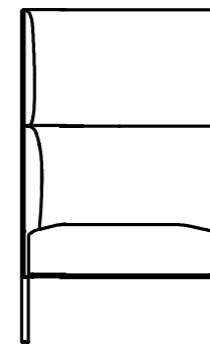
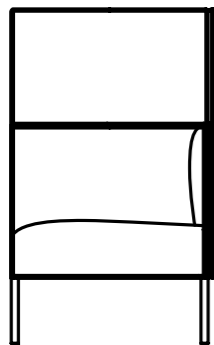

M22-22-0

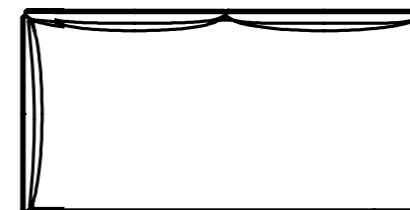
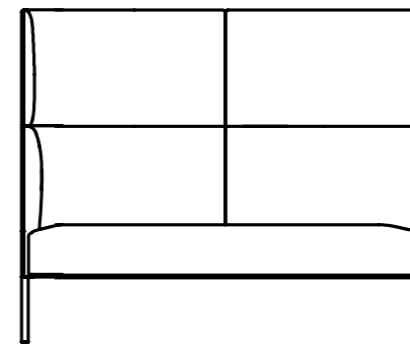

M32-222-0

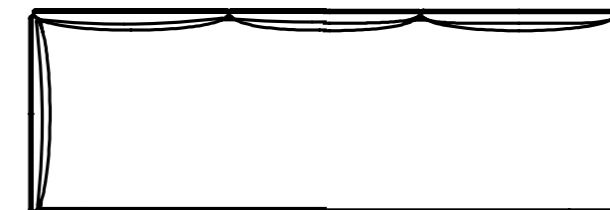
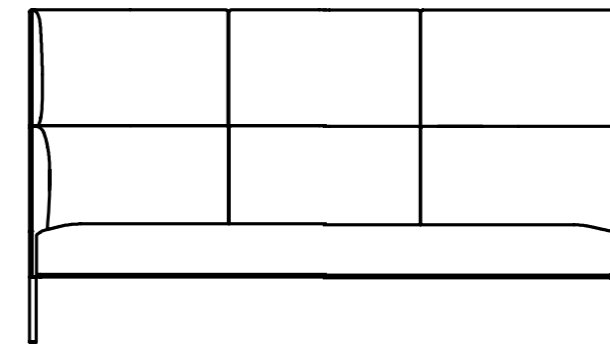

MOLTO | Open 2 sides - 1 height

M10-1-0

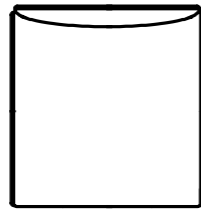
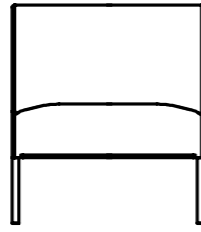
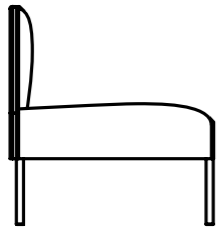

M20-11-0

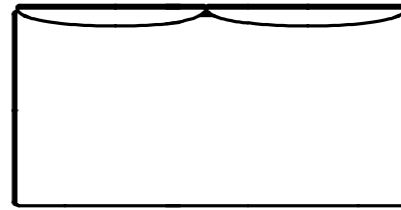
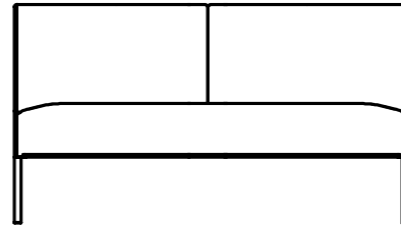

M30-111-0

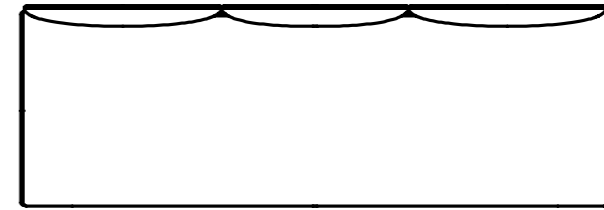
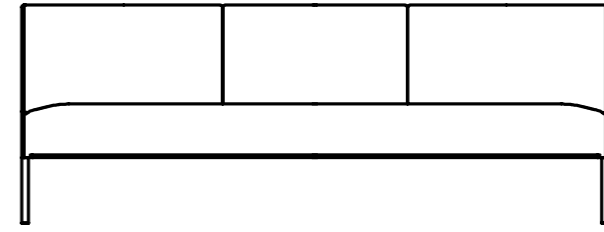

MOLTO | Open 2 sides - 2 heights

M10-2-0

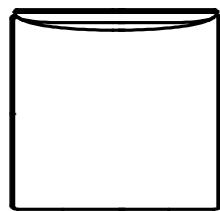
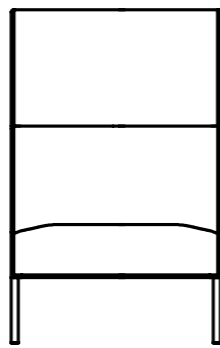
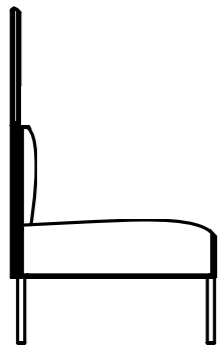

M20-22-0

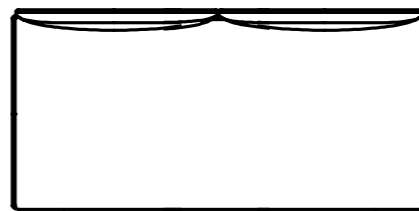
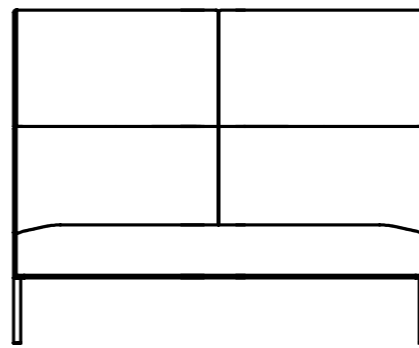

M30-222-0

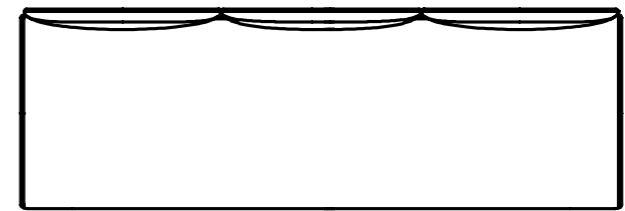
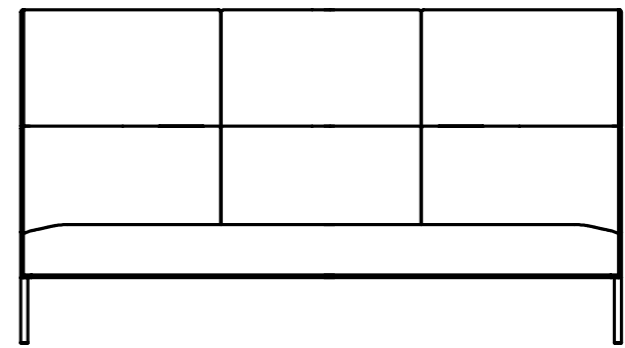

MOLTO | Mixed heights - 2 seater

M21-10-0

M20-01-1

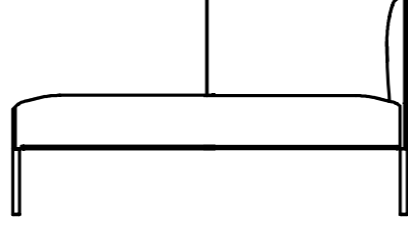
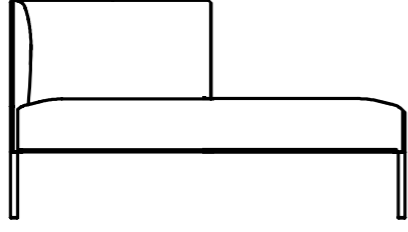
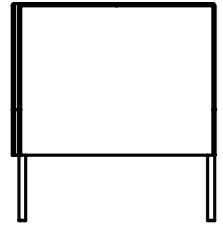

M22-21-1

M21-12-2

M22-20-0

M20-02-2

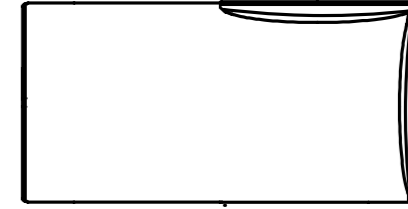
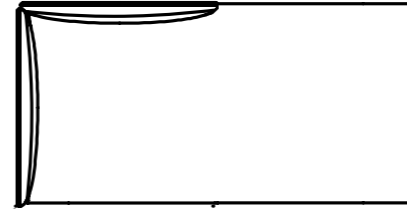
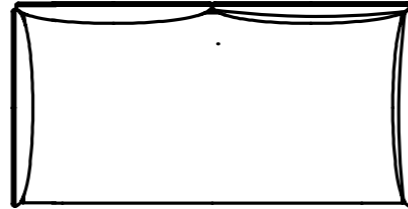
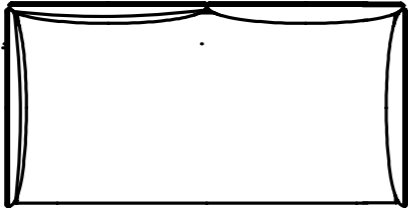
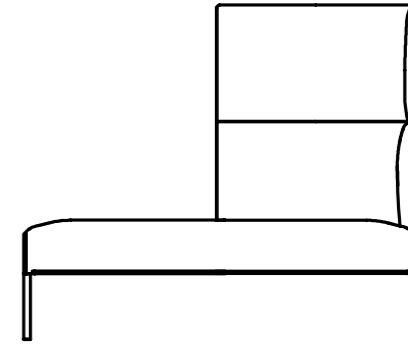
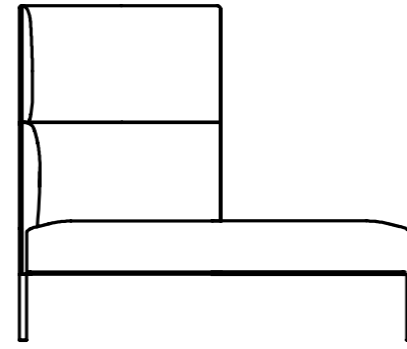
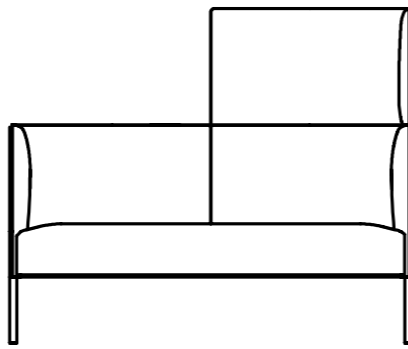
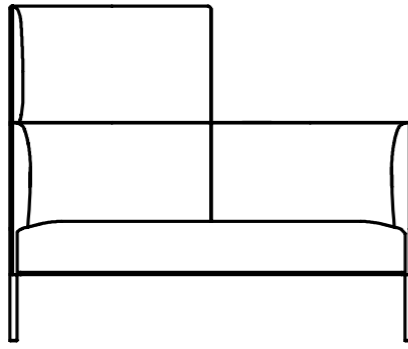
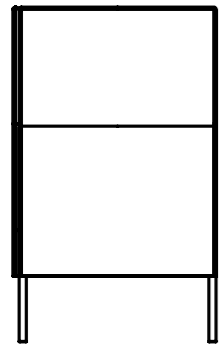

MOLTO | Mixed heights 1/0 - 3 seater

M31-100-0

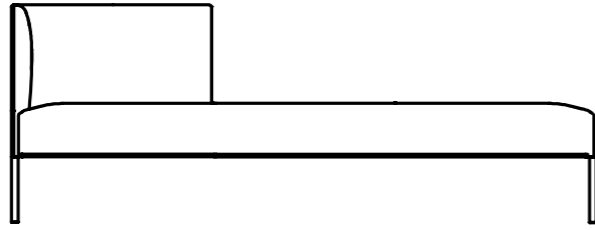
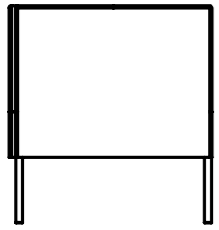

M30-001-1

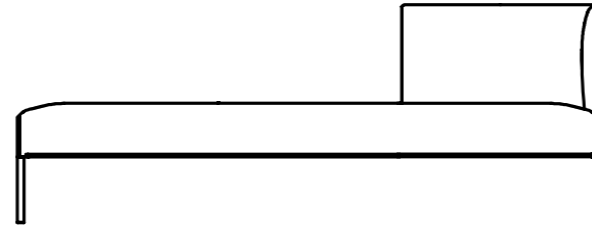

M31-101-1

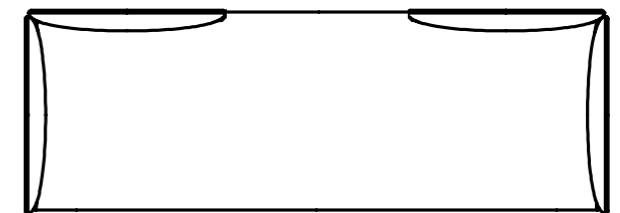
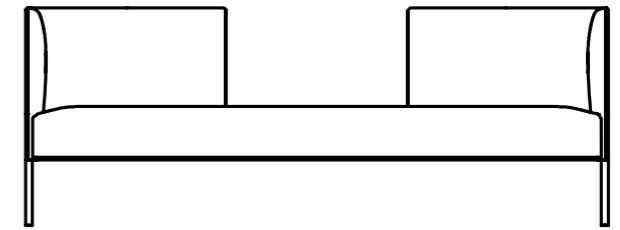

M31-110-0

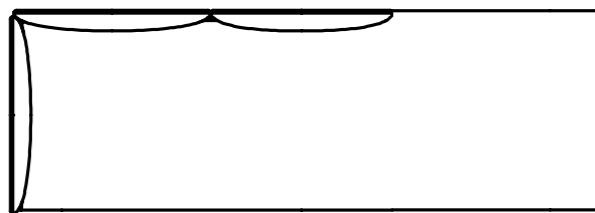
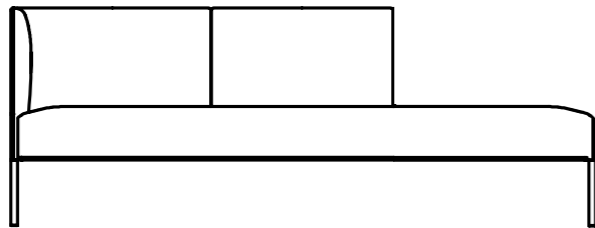

M30-011-1

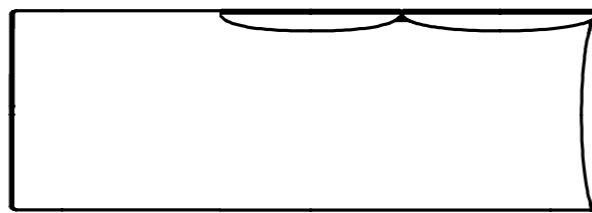
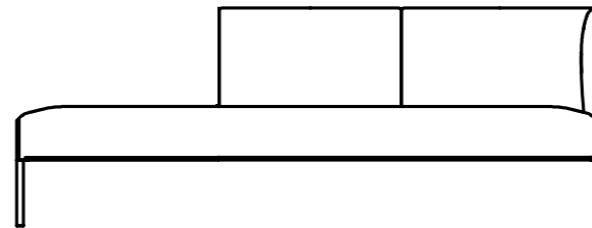

MOLTO | Mixed heights 2/1 - 3 seater

M32-211-1

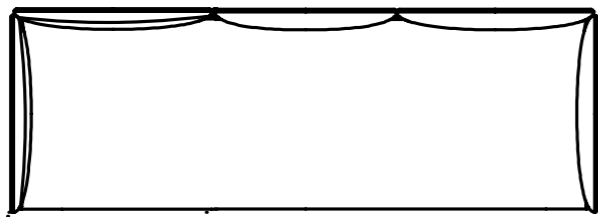
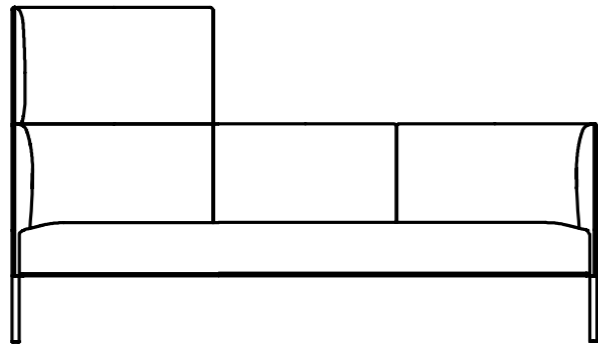
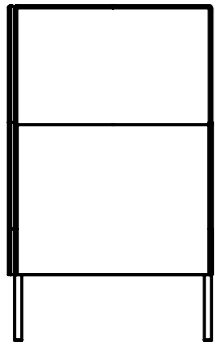

M31-112-2

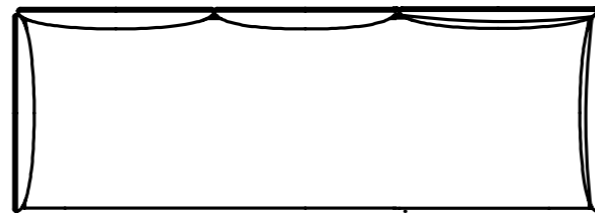
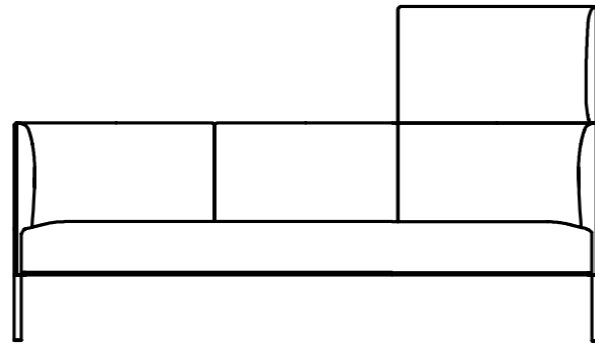

M32-212-2

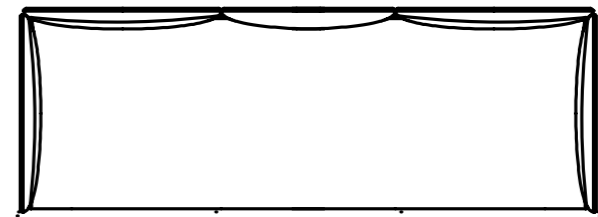
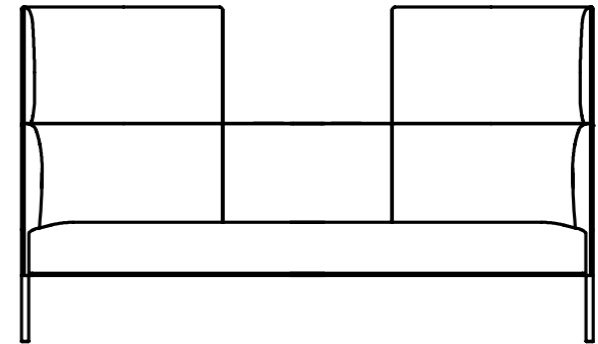

M32-221-1

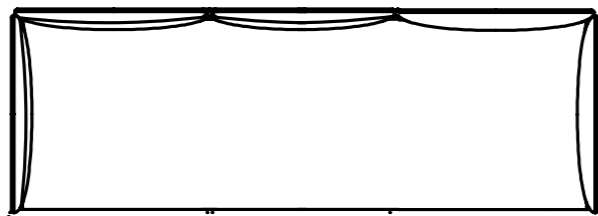
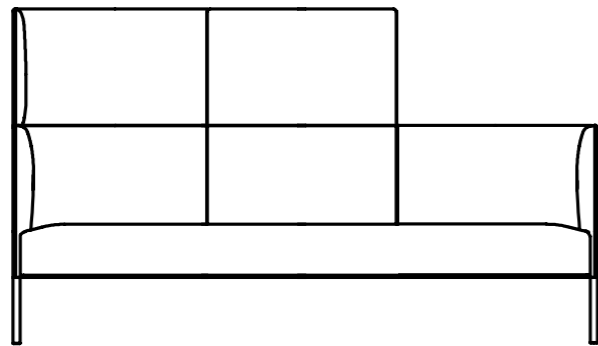

M31-122-2

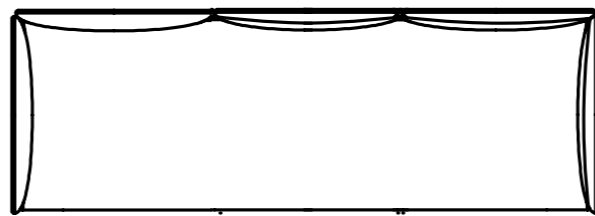
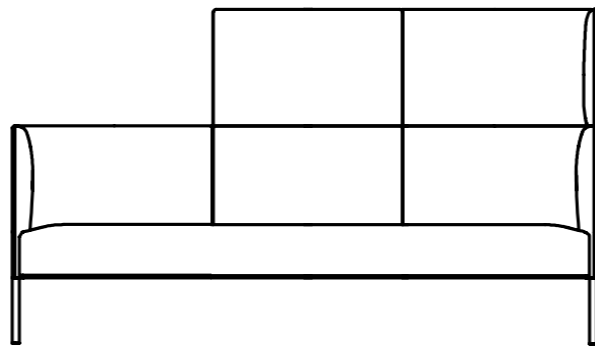

MOLTO | Mixed heights 2/0 - 3 seater

M32-200-0

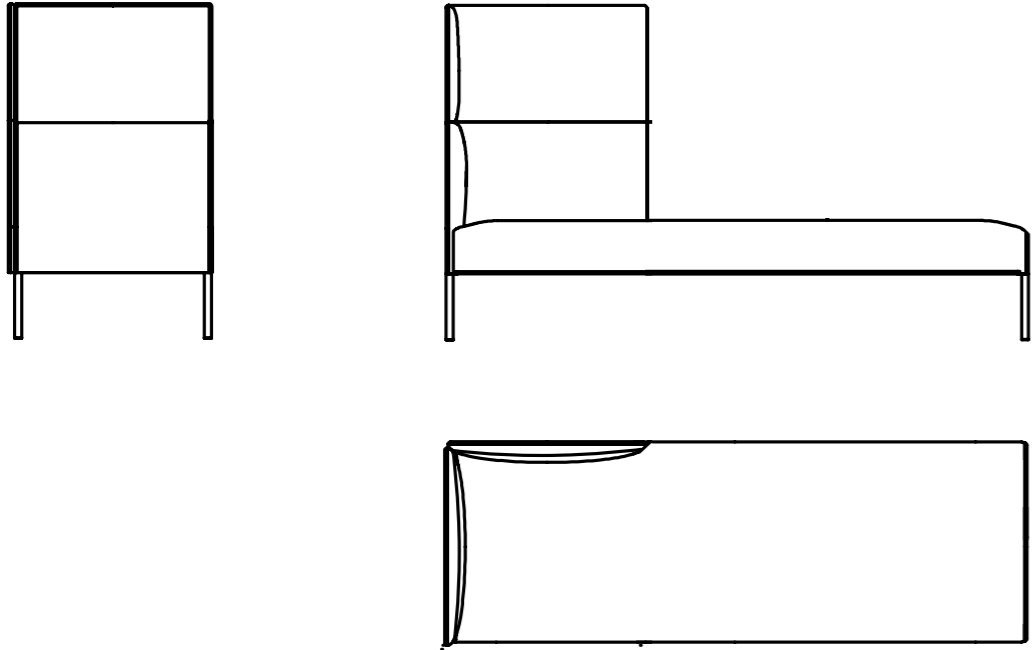

M30-002-2

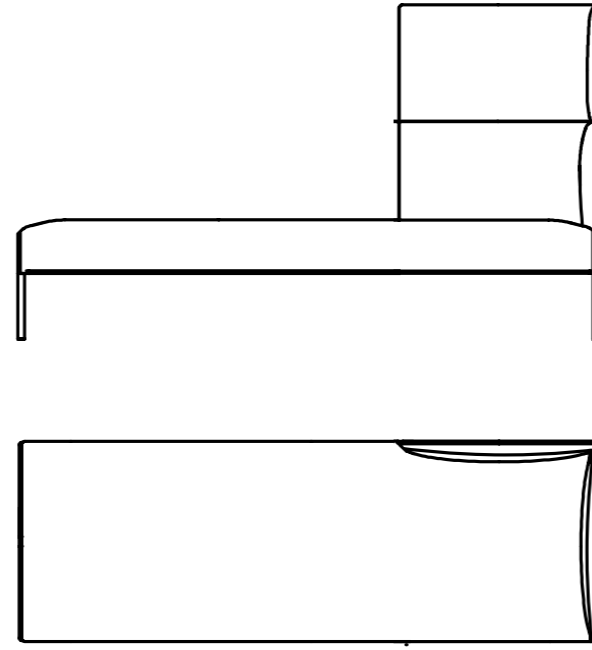

M32-202-2

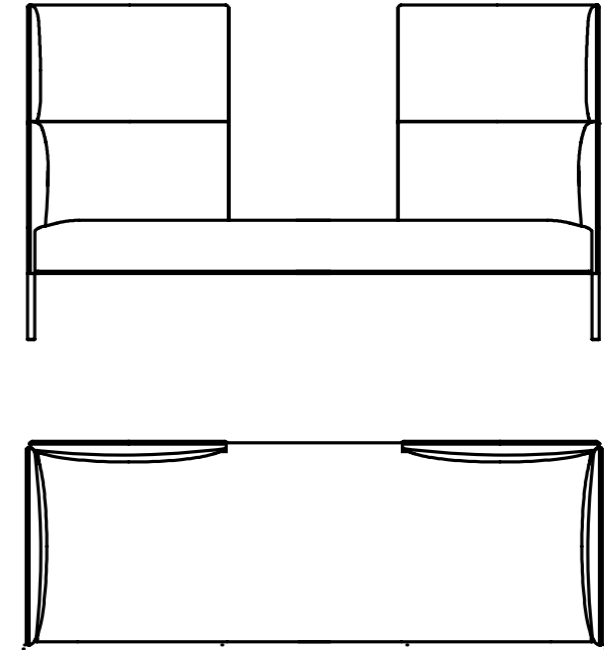

M32-220-0

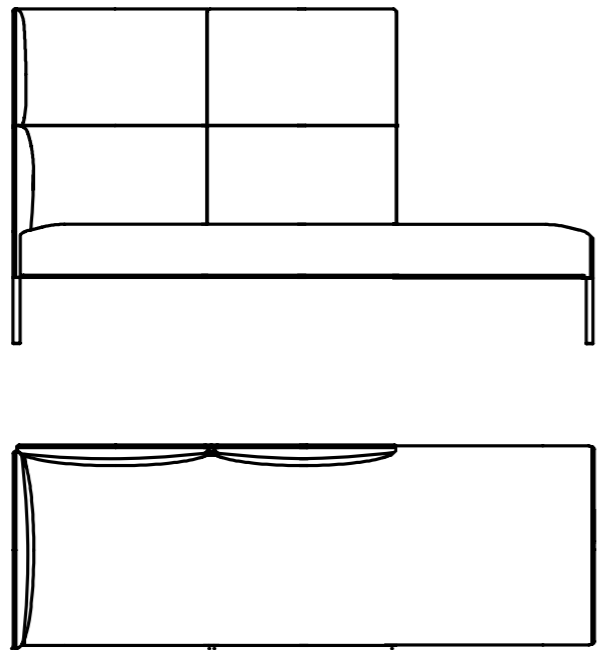

M30-022-2

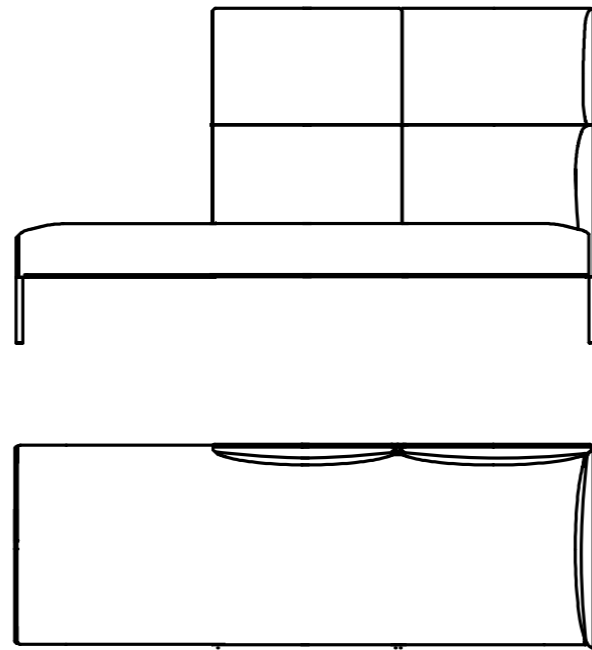

MOLTO | Mixed heights 2/1/0 - 3 seater

M32-210-0

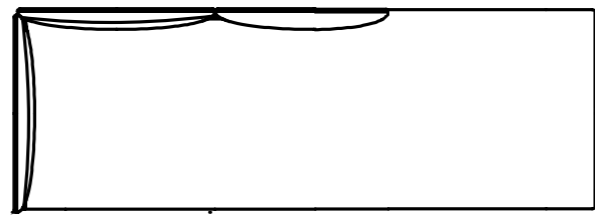
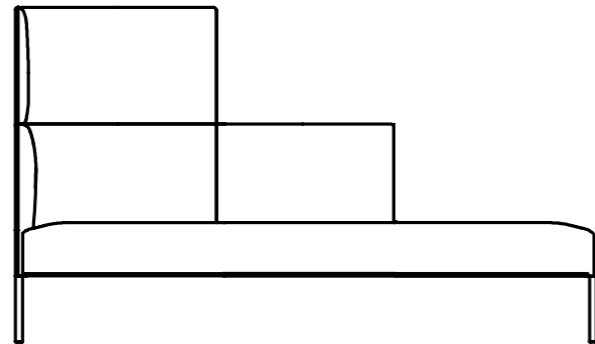
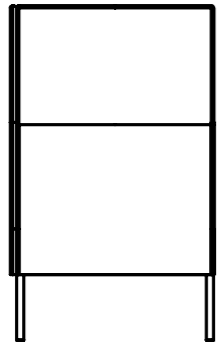

M30-012-2

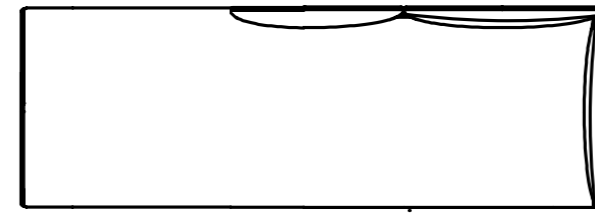
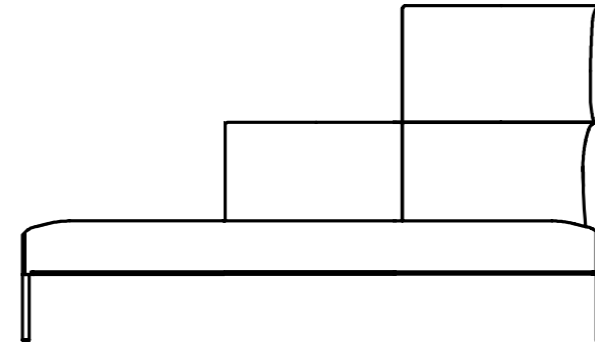

M32-201-1

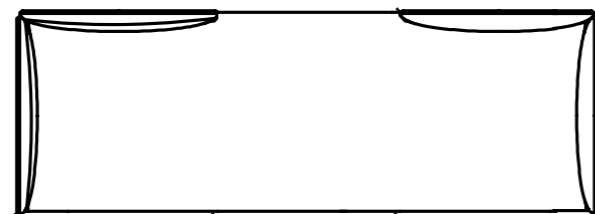
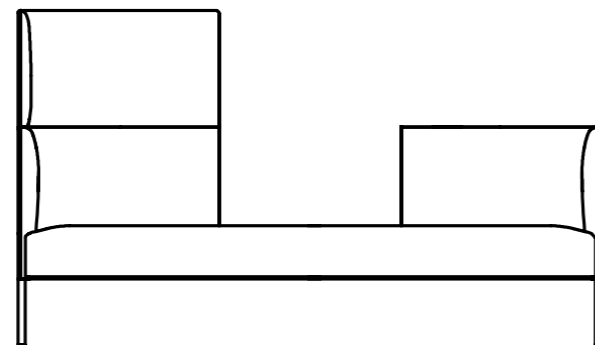

M31-102-2

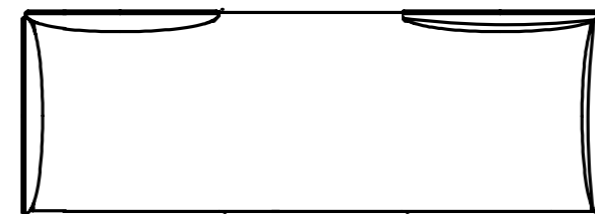
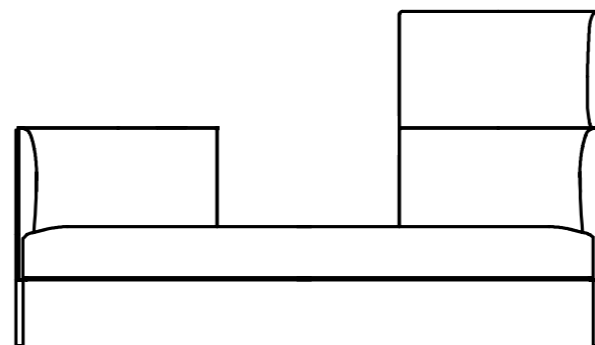

MOLTO | Open side, mixed heights - 2 seater

M22-21-0

M20-12-2

M20-21-1

M21-12-0

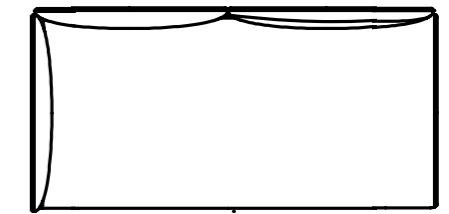
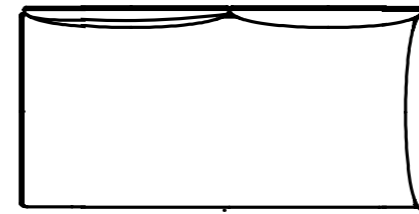
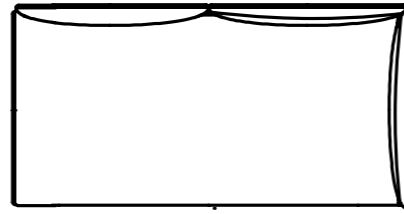
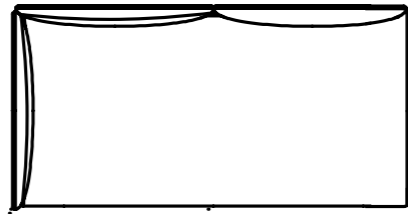
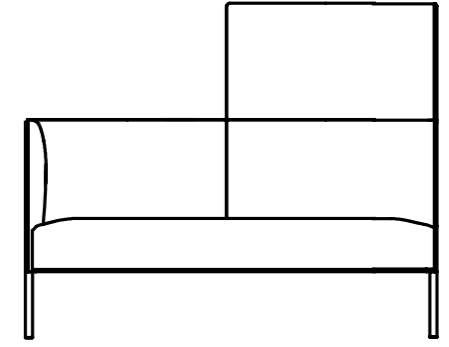
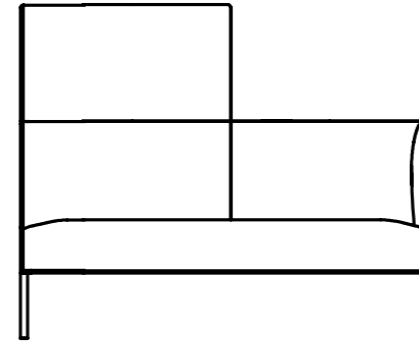
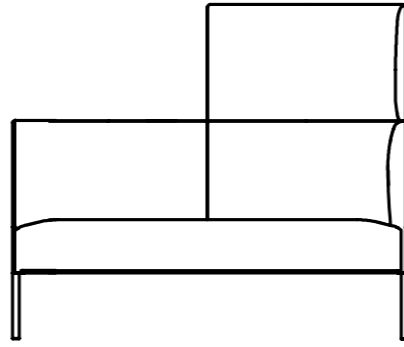
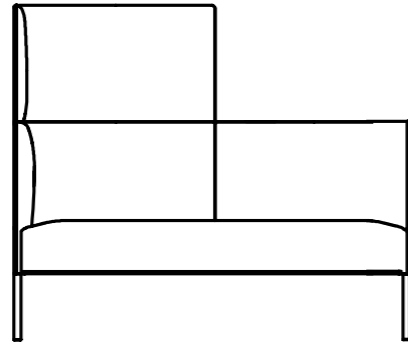
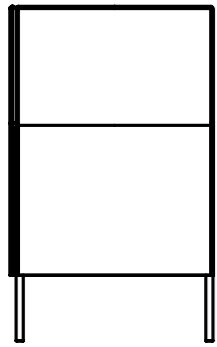

MOLTO | Open sides, mixed heights - 2 seater

M20-10-0

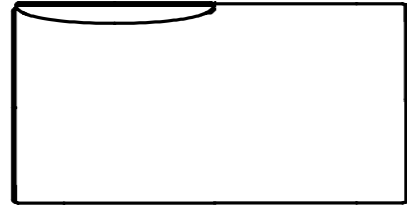
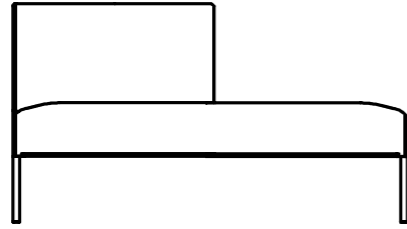
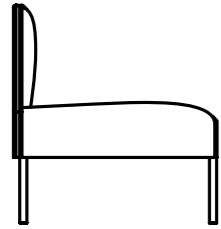

M20-01-0

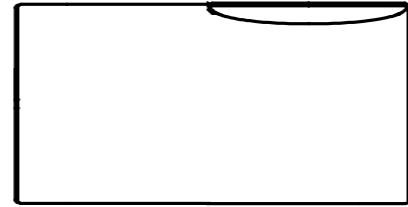
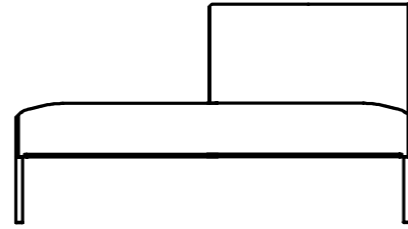

M20-20-0

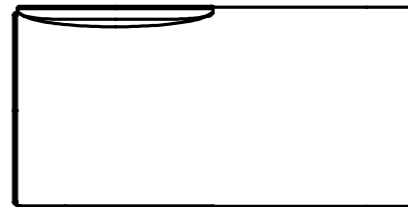
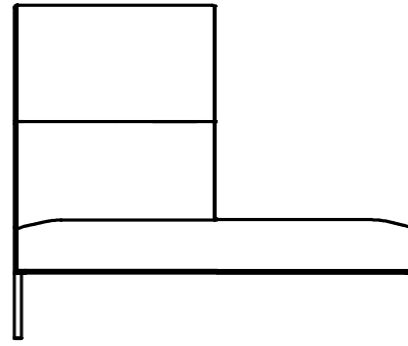

M20-02-0

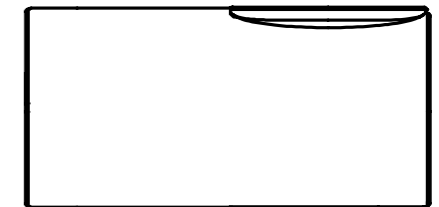
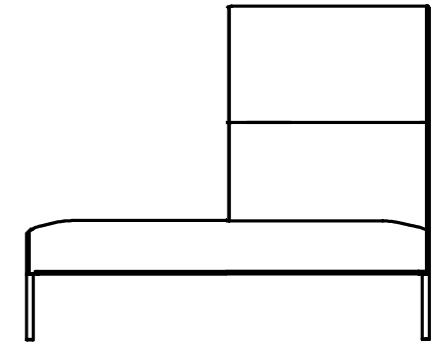

M20-21-0

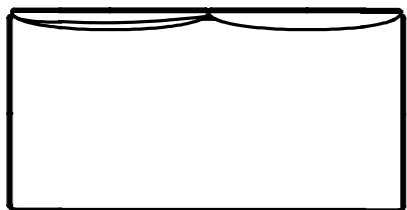
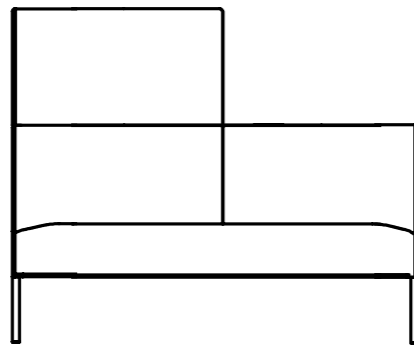
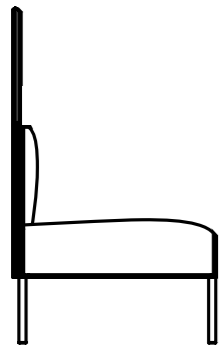

M20-12-0

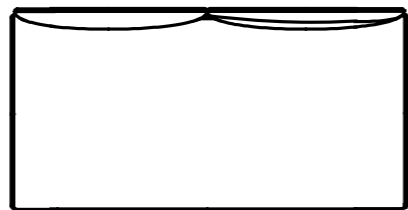
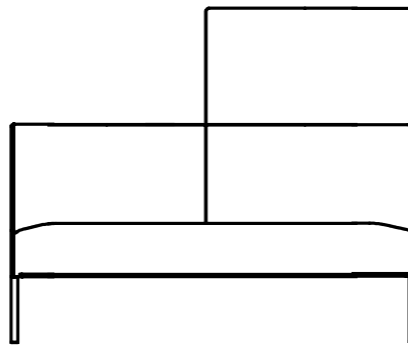

MOLTO | Open sides, mixed heights 1/0 - 3 seater

M30-100-0

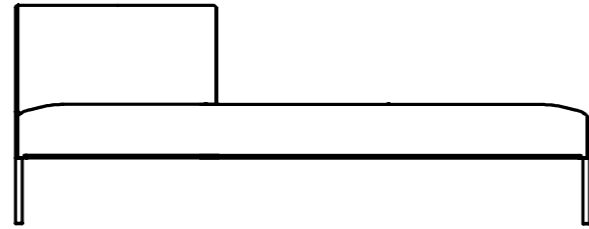

M30-001-0

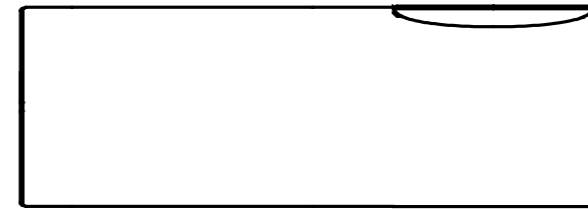
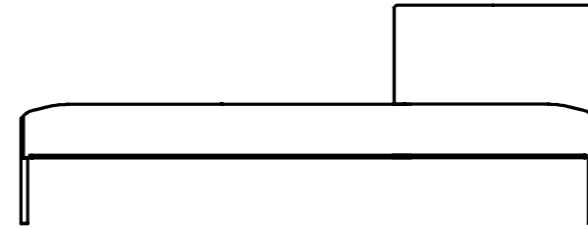

M30-101-1

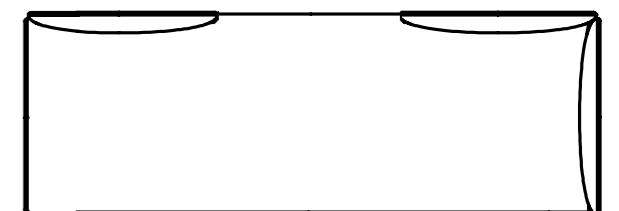
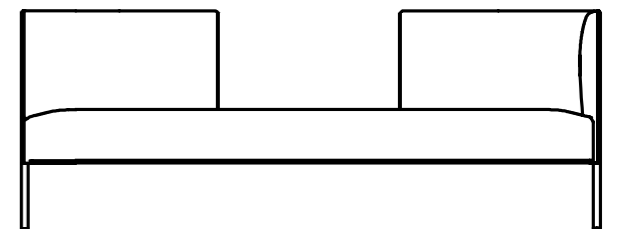

M31-101-0

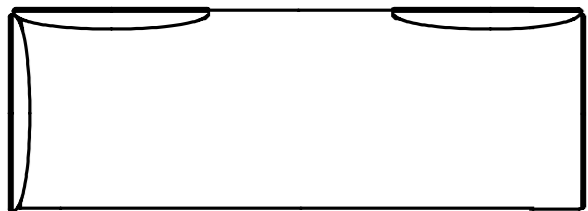
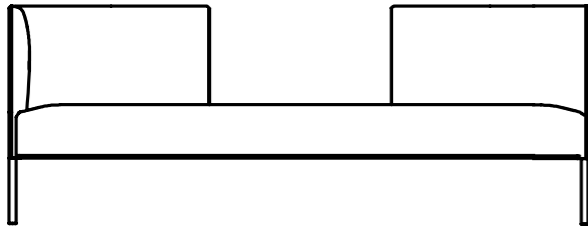

M30-101-0

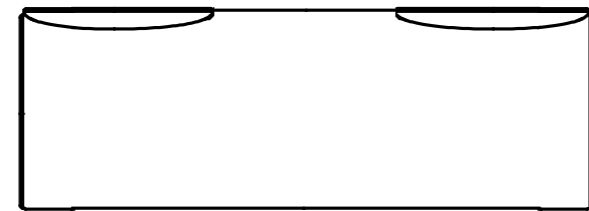
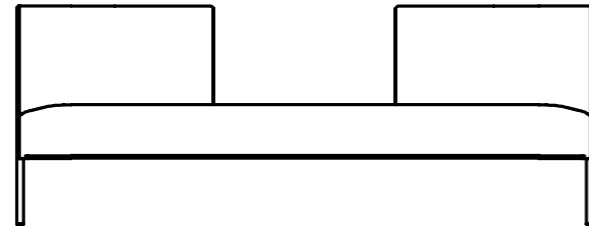

M30-110-0

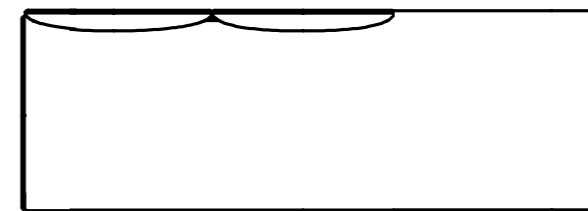
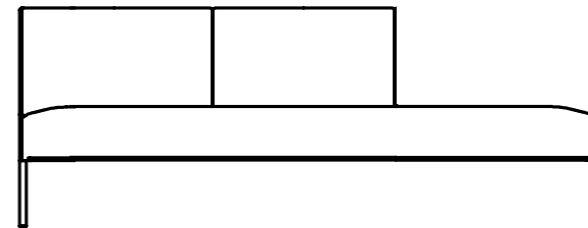

M30-011-0

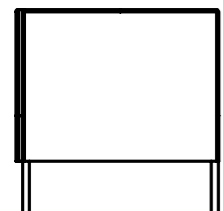
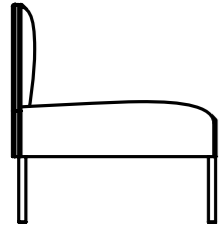
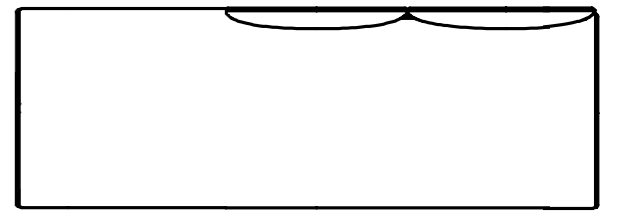
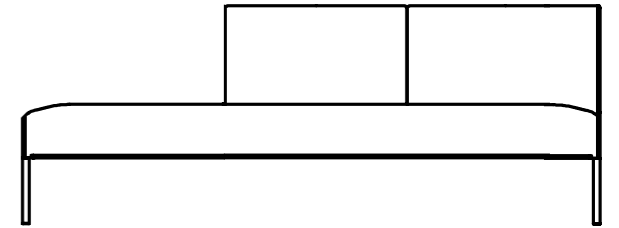

MOLTO | Open side, mixed heights 2/1 - 3 seater

M32-211-0

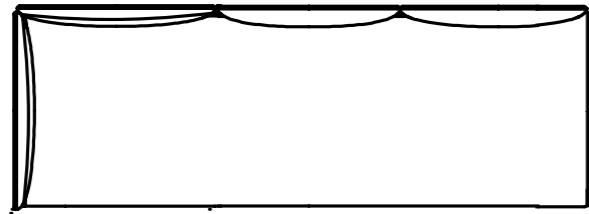
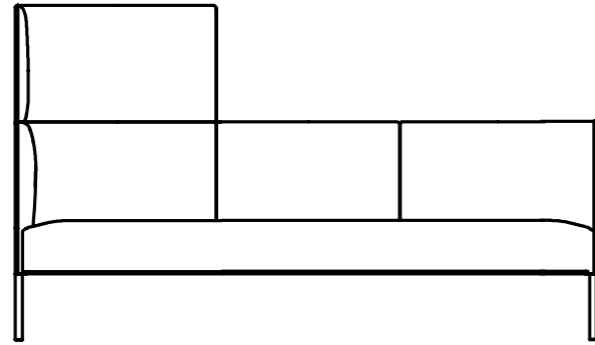
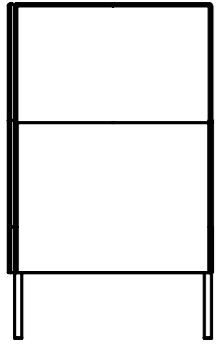

M30-112-2

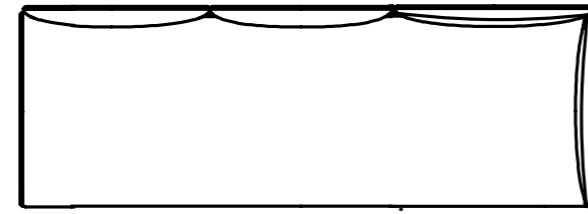
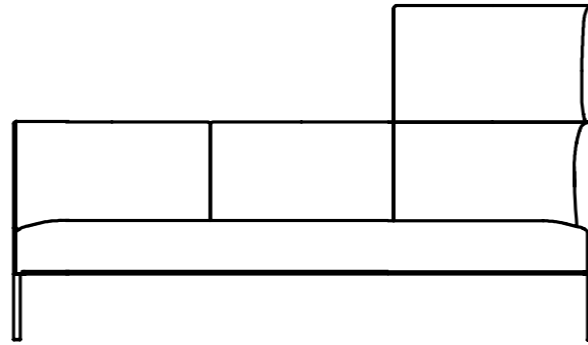

M30-211-1

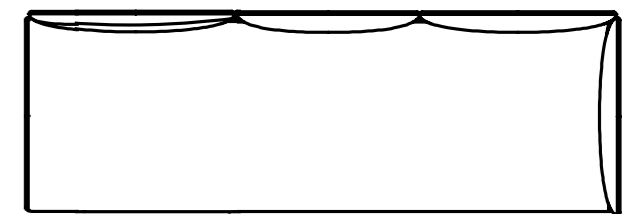
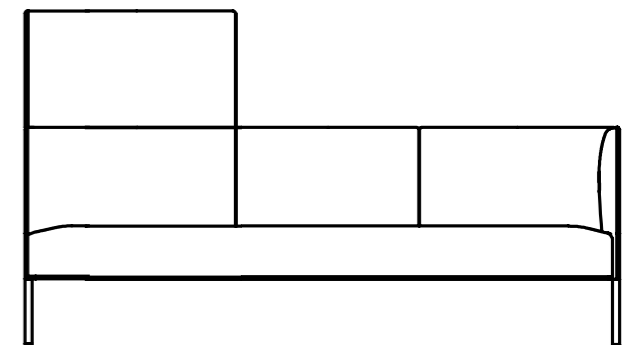

M31-112-0

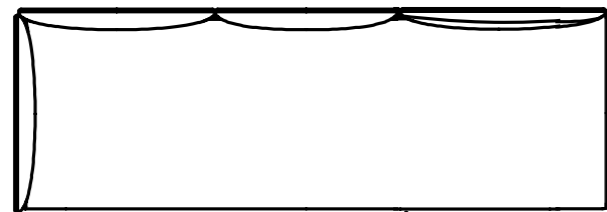
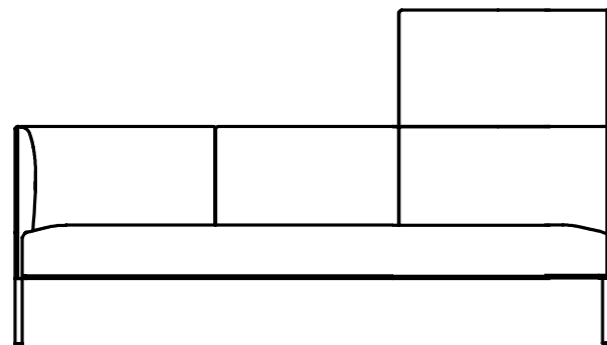

M30-211-0

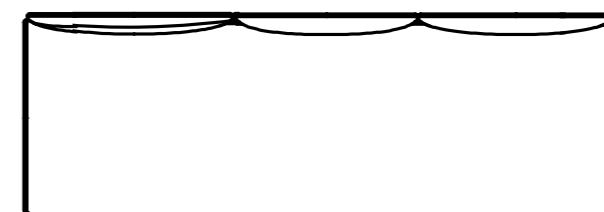
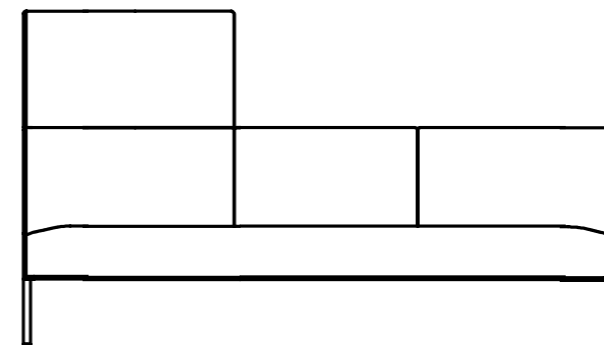
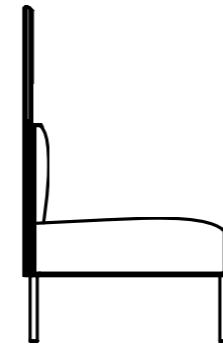

M30-112-0

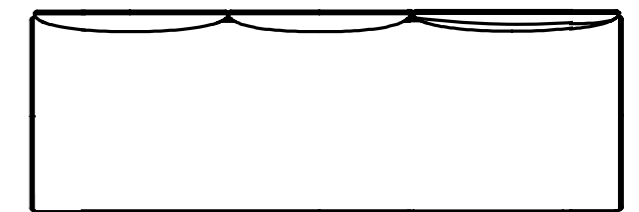
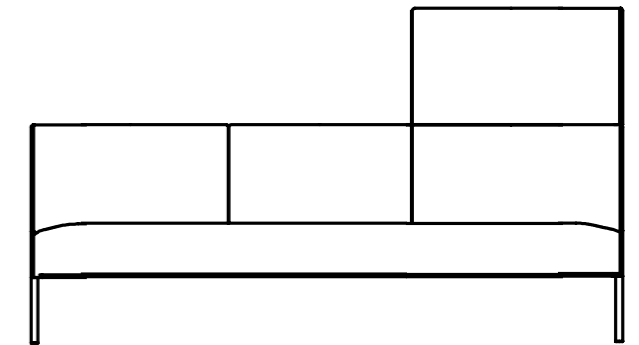

MOLTO | Open side, mixed heights 2/1 - 3 seater

M32-221-0

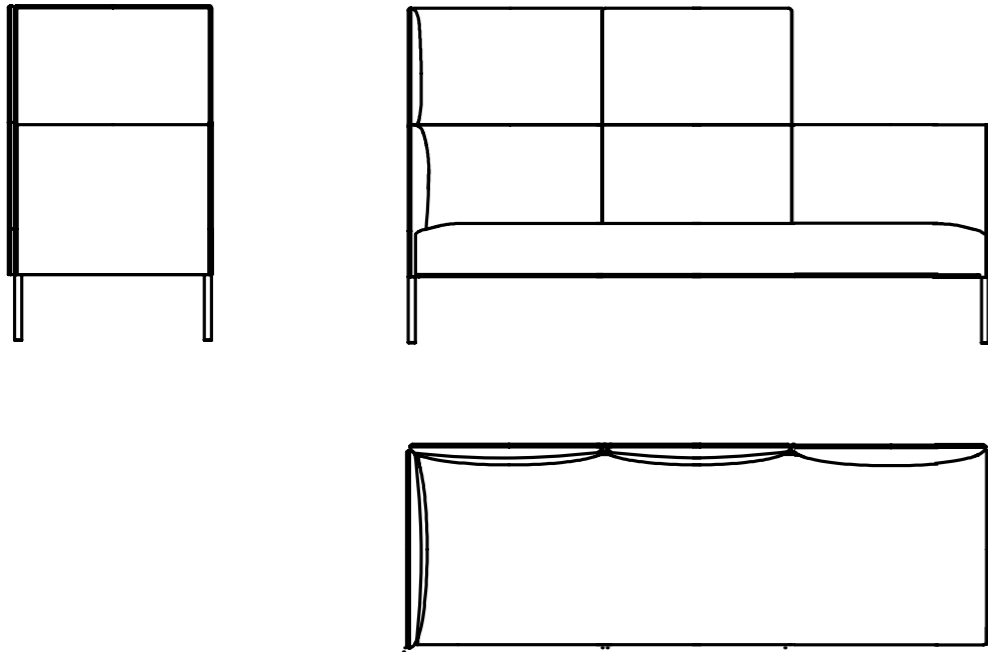

M30-122-2

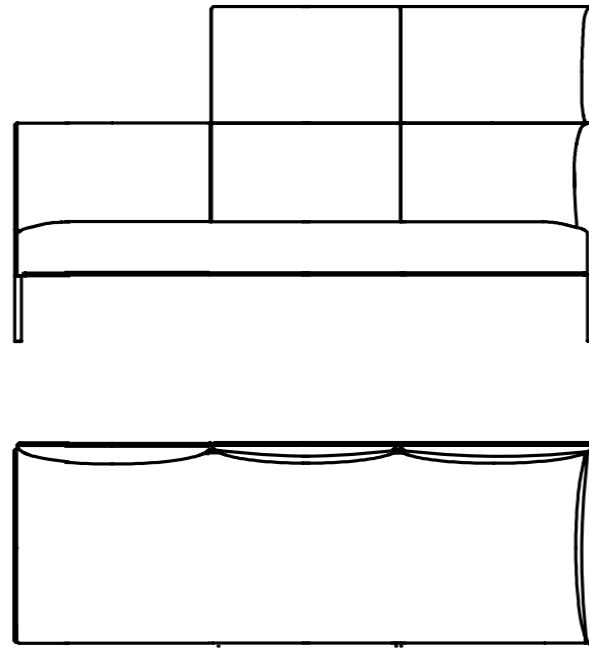

M30-221-1

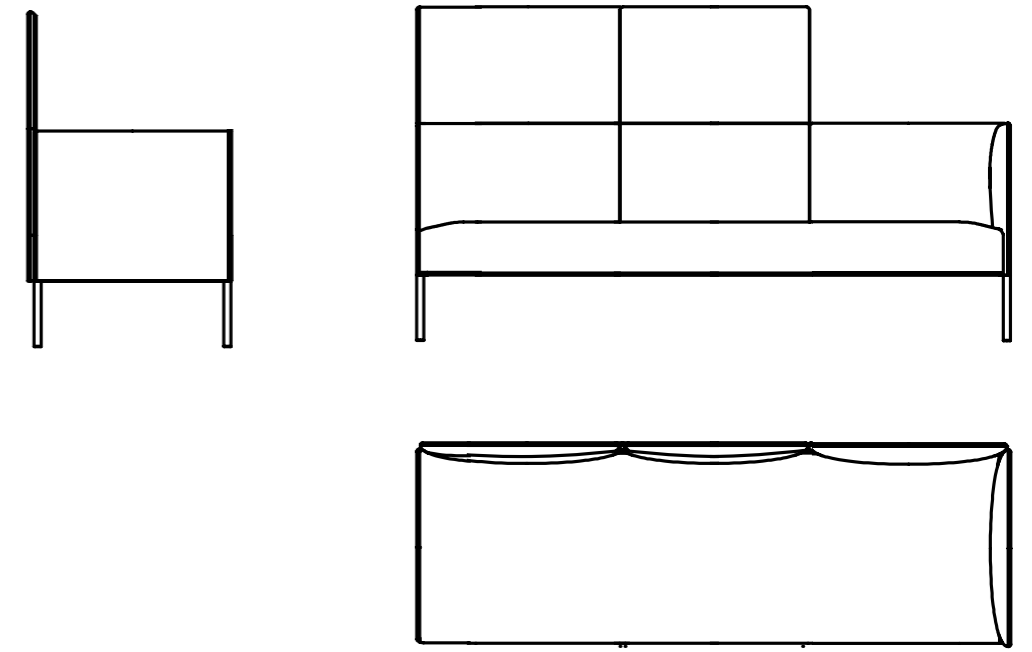

M31-122-0

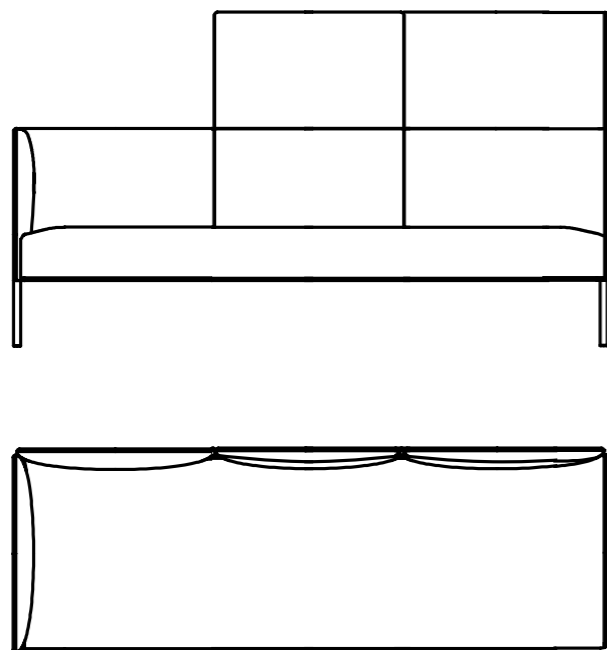

M30-221-0

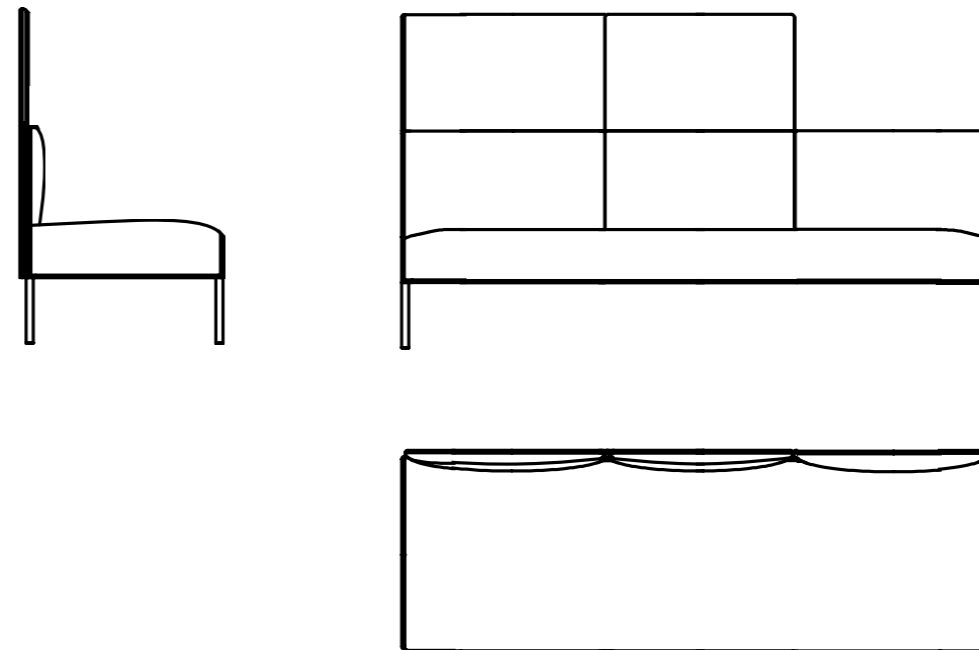

M30-122-0

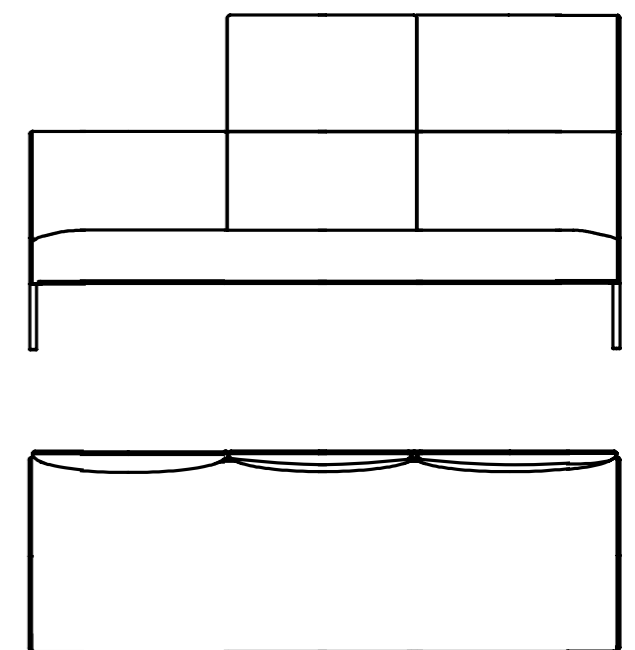

MOLTO | Open sides, mixed heights 2/0 - 3 seater

M30-200-0

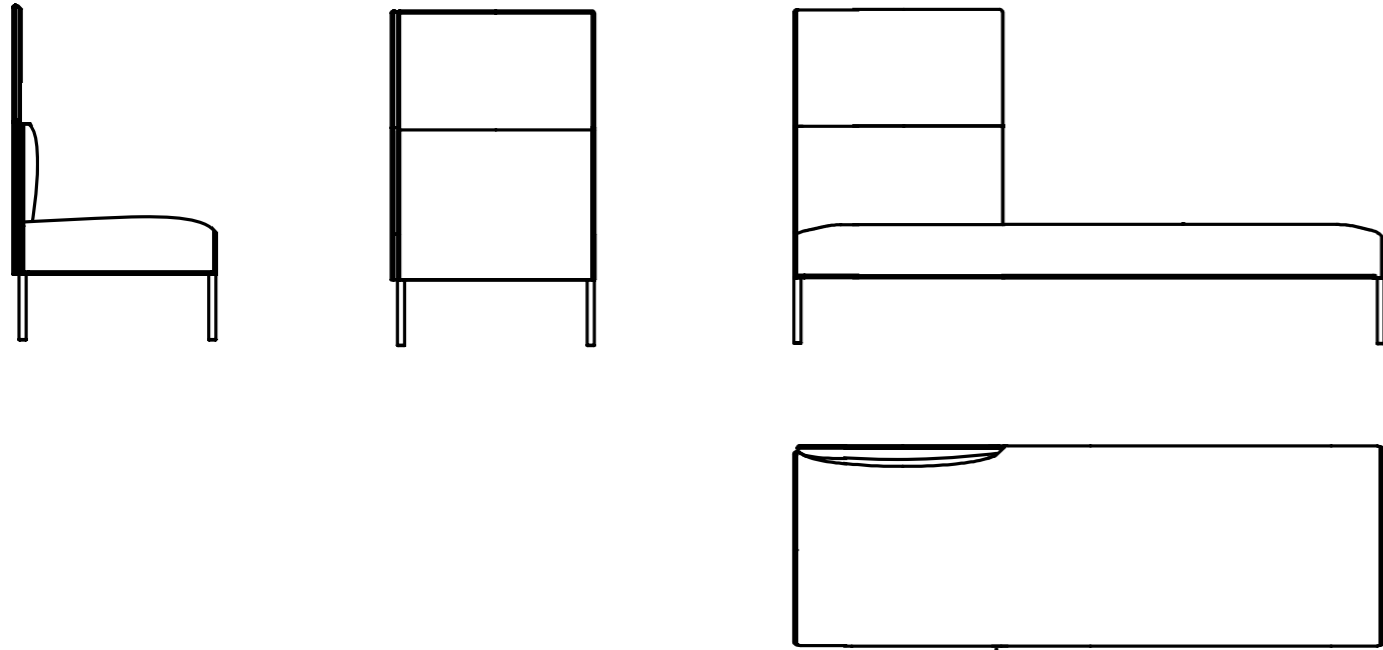

M30-002-0

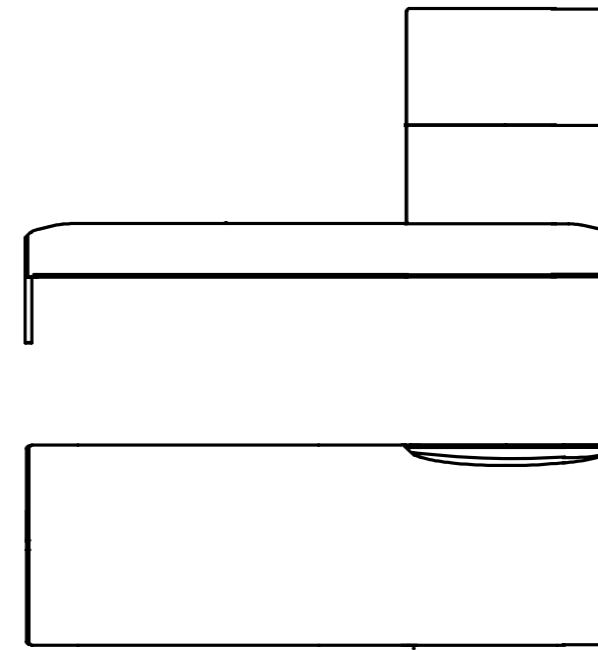

M30-202-2

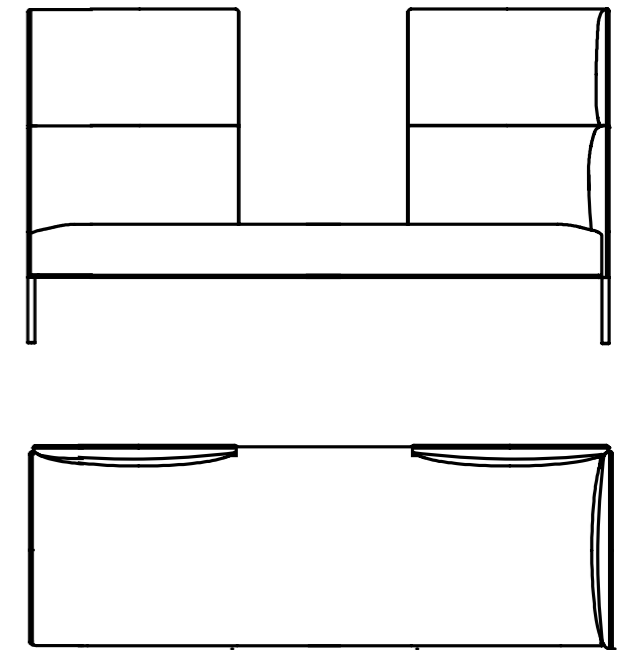

M30-202-2

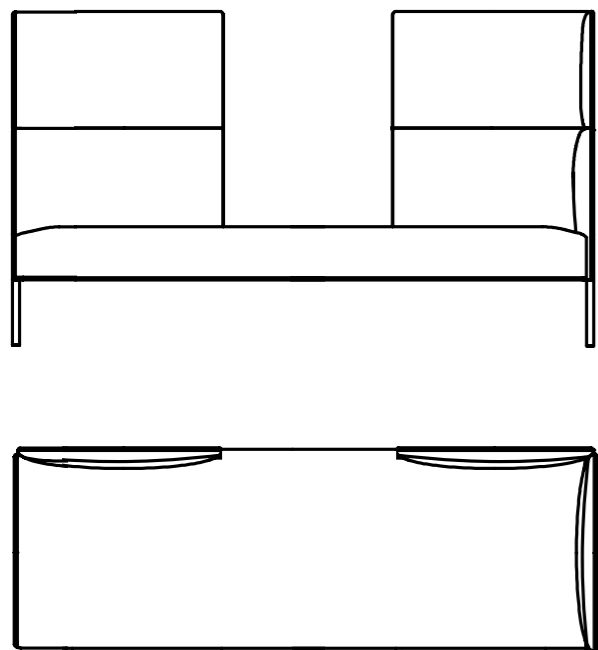

M30-202-0

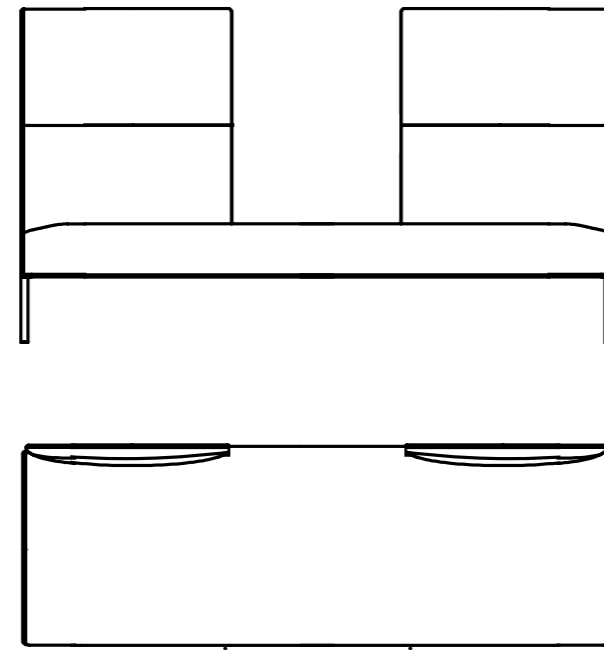

M30-220-0

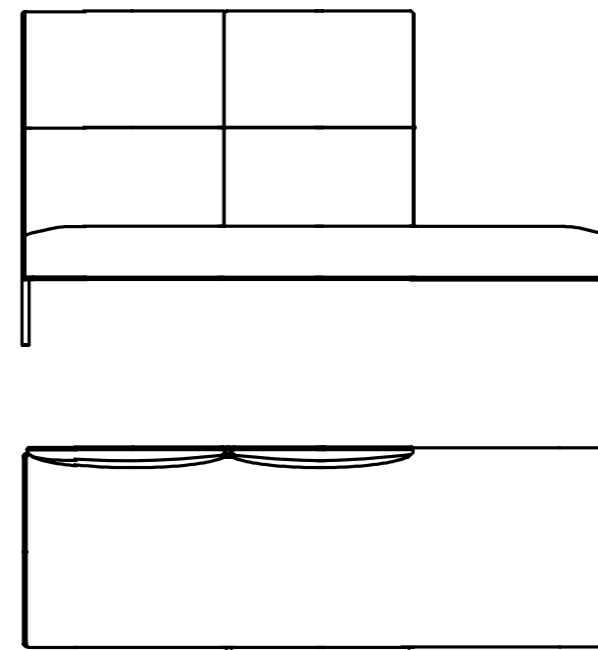

M30-022-0

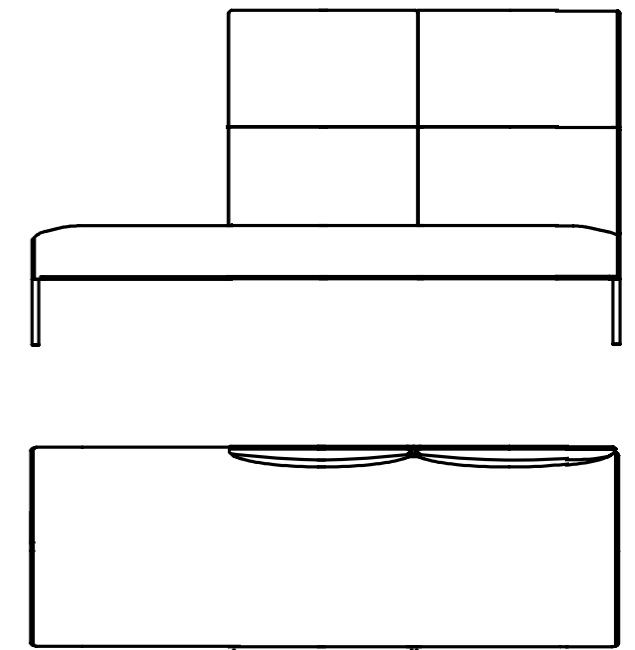

MOLTO | Open sides, mixed heights 2/1/0 - 3 seater

M30-201-1

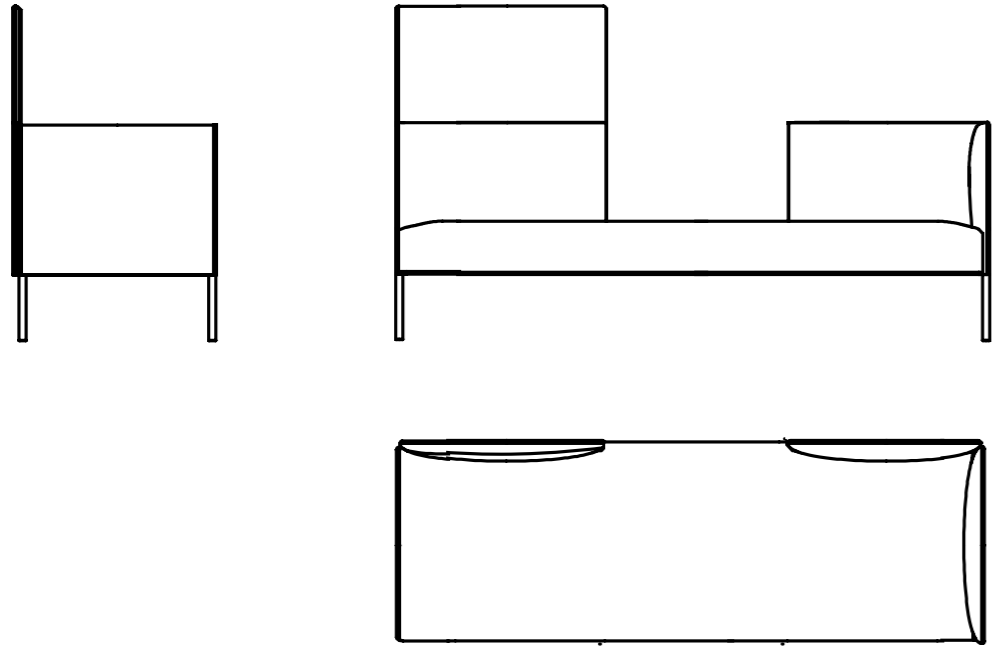

M31-102-0

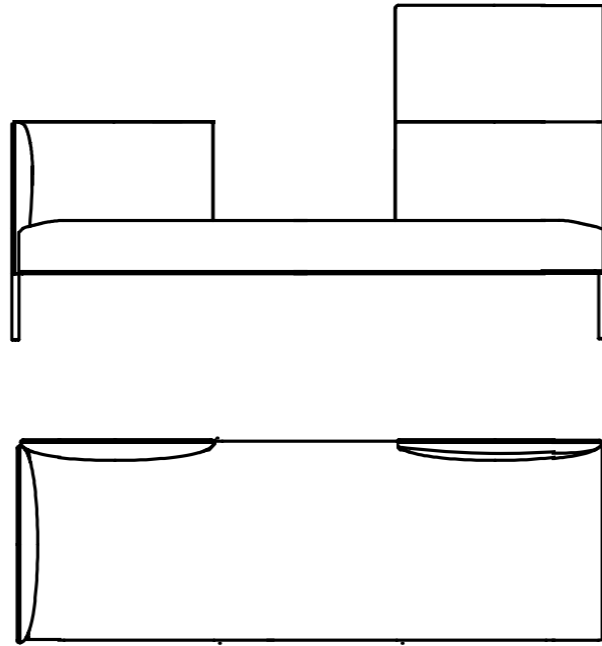

M32-201-0

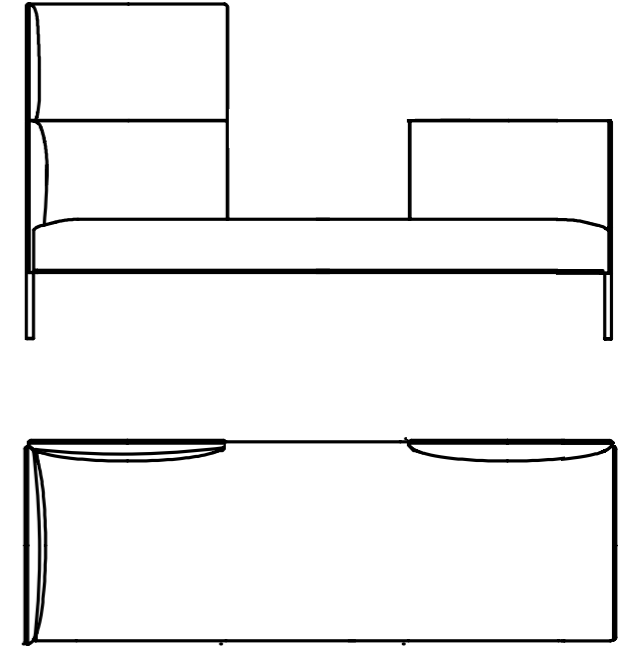

M30-102-2

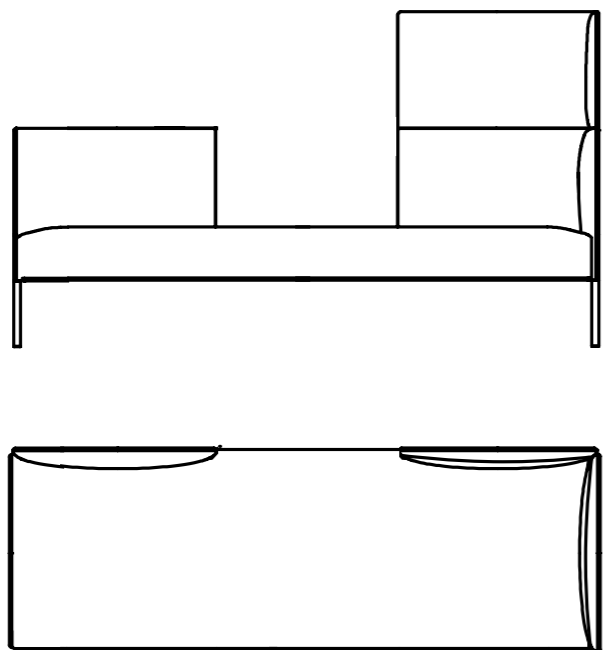

M30-201-0

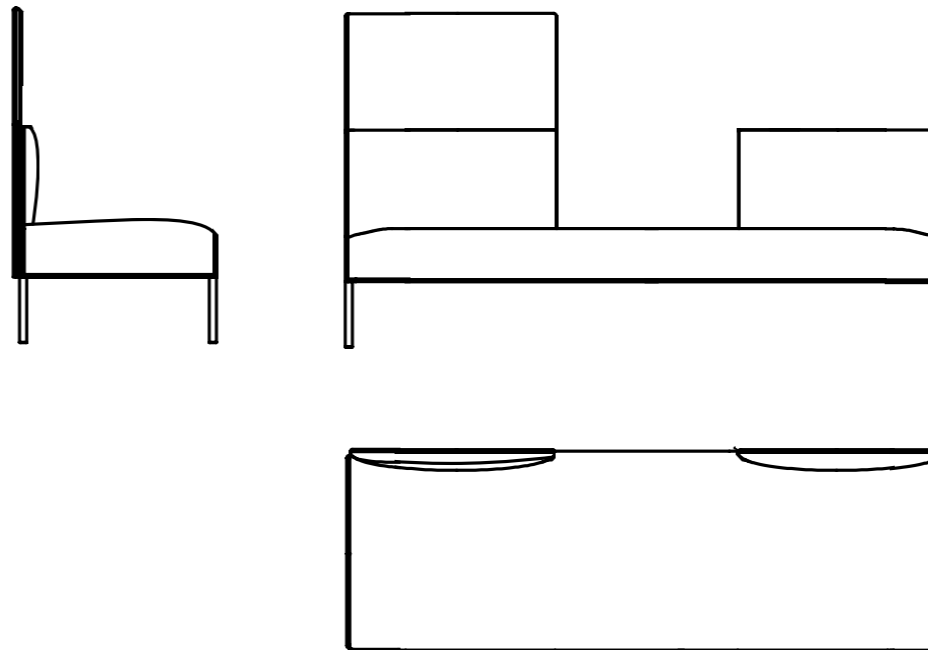

M30-102-0

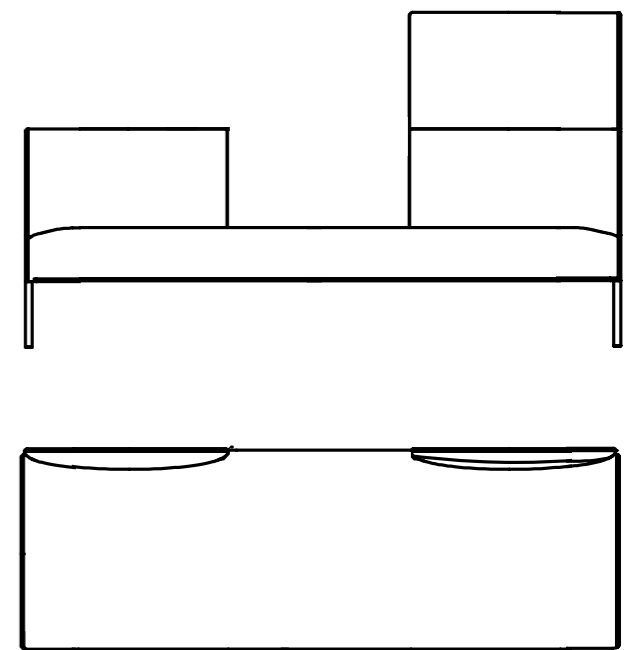

MOLTO | Open sides, mixed heights 2/1/0 - 3 seater

M30-210-0

M30-012-0

